



**Reno A & E**  
 4655 Aircenter Circle  
 Reno, NV 89502-5948 USA  
 Telephone: (775) 826-2020  
 Facsimile: (775) 826-9191  
 Website: www.renoae.com  
 E-mail: contact@renoae.com



## MODEL U-1400 OPERATION MANUAL

Four Loop Inputs, Eight Vital Outputs, and Four Vital Inputs



**Built-in  
 Loop Analyzer  
 For Each Channel**

**Four Channel Menu Driven Programmable Inductive Loop Vehicle Detector  
 Designed for Railroad Applications**

2/14/05

This page intentionally left blank.

# MODEL U-1400 OPERATION MANUAL

## TABLE OF CONTENTS

1.0	GENERAL DESCRIPTION .....	5
2.0	GENERAL CHARACTERISTICS .....	6
2.1	Loop Frequency .....	6
2.2	Sensitivity .....	6
2.3	Option 1, Loop Inductance Display .....	6
2.4	Option 2, Loop Inductance $-\Delta L/L$ Display .....	6
2.5	Option 3, Noise Filter .....	6
2.6	Option 4, Detection Zone Tracking .....	7
2.7	Option 5, Sensitivity Boost .....	7
2.8	Option 6, Audible Detect Signal .....	7
2.9	Loop Check .....	7
2.10	Detector ID .....	7
2.11	Option 7, Synch Feature .....	8
2.12	Primary Vital Output Delay .....	8
2.13	Primary Vital Output Extension .....	8
2.14	Input / Output Mapping .....	8
2.15	Full Restore To Factory Default Settings .....	8
2.16	Diagnostic Features Activation .....	8
3.0	SPECIFICATIONS .....	9
3.1	Physical .....	9
3.2	Electrical .....	9
3.3	Operational .....	10
3.4	TABLE: Sensitivity, $-\Delta L/L$ , & Response Time .....	12
3.5	TABLES: Default Settings .....	13
3.6	TABLES: Pin Assignments .....	14
3.7	TABLE: Pin Assignments / Wire Colors .....	17
4.0	USER INTERFACE .....	18
5.0	INSTALLATION AND SET-UP .....	19
5.1	Initial Installation Start-up Mode Display Screens .....	20
5.2	Program Mode Display Screens .....	21
5.2.1	Primary Vital Output ( <i>Vital Out</i> ) Mapping Screens .....	24
5.2.2	Auxiliary Vital Output ( <i>Vital Aux</i> ) Mapping Screens .....	27
5.3	Normal Mode Display Screens .....	31
5.4	Error Message Display Screens .....	33
5.5	Loop Check Pass / Fail Indications .....	35
5.6	Vital Input ( <i>Vital In</i> ) Status / Fail Indications .....	36
5.7	Primary Vital Output ( <i>Vital Out</i> ) Status / Fail Indications .....	36
5.8	Auxiliary Vital Output ( <i>Vital Aux</i> ) Status / Fail Indications .....	36
5.9	Synch Fail Indications .....	36
5.9.1	Series Synch Fail Indications .....	36
5.9.2	Parallel Synch Fail Indications .....	36
5.10	Loop Fail Indications .....	37
5.11	Setting Sensitivity using the Bargraph .....	37
5.12	Full Restore To Factory Default Settings .....	38
5.13	Diagnostic Features Activation .....	38
5.14	Display Test .....	38
5.15	Changing or Relocating Detectors .....	38
6.0	BLOCK DIAGRAM .....	39
7.0	THEORY OF OPERATION .....	40
8.0	MAINTENANCE AND TROUBLESHOOTING .....	41
8.1	Basic Troubleshooting Tips .....	41
8.2	Things To Know About Loops .....	42

This page intentionally left blank.

## 1.0 GENERAL DESCRIPTION

This product manual was written for people installing, operating, and maintaining the Reno A&E Model U-1400 inductive loop vehicle detector. The Model U-1400 is a stand-alone, box type, four-channel inductive loop vehicle detector. It is designed to be used in applications requiring detection of railway vehicles in large detection areas typically required in classification yard switch and sideswipe protection, interlocking and moveable bridge occupancy detection, or detection of roadway vehicles and/or railway vehicles in at-grade crossing sites.

The Model U-1400 monitors and processes signals from four loop / lead-in circuits, four check loop circuits, and four Vital inputs. These inputs can be programmed to control eight Vital outputs, four primary Vital outputs and four auxiliary Vital outputs. Each of the four primary Vital outputs can be controlled by any combination of the four loop inputs and/or any combination of the four Vital inputs. In addition to the four loop inputs and four Vital inputs (as described above), the four auxiliary Vital outputs can be controlled by the four loop Health Status inputs that are continuously monitored by the processor. A loop failure will deactivate the Vital output that the loop status input and/or loop Health Status input is programmed to control. The check loop circuits can be programmed to simulate a vehicle detection (every 1 to 255 minutes) in the loop area as a means of verifying proper loop operation. The Vital outputs and Vital inputs are monitored to ensure they are in the correct state. If the state of a Vital input is not correct, the front panel LED indicator corresponding to that input will turn red and all Vital outputs will be deactivated. If the state of any Vital output is not correct, the front panel LED corresponding to that output will turn red and all Vital outputs will be deactivated.

A Liquid Crystal Display (LCD), sixteen LEDs, and four front panel pushbuttons are used to display and program all detector functions. The Model U-1400 also incorporates a series of front panel mounted connectors to facilitate set-up and operation. A 55 pin circular connector is used for detector input and output connections, a 15 pin D-subminiature connector is used to allow connection of an external EEPROM memory module, and a nine pin RS-232 connector is used for communication with a laptop computer.

The use of a LCD is one feature that distinguishes this detector from that of other manufacturers. It allows for more information, never before available, to be displayed to the user during normal operation of the detector. Several diagnostic modes are available to aid the technician in troubleshooting detection problems. It also allows easy viewing and setting of all programmable values in the detector. The detector continues to operate normally while being programmed. An eight-segment bargraph at the top of the LCD provides a graphical representation of the relative change of inductance as seen by the detector. This automatically takes into account loop size, loop inductance, number of loops, number of turns, geometry, lead-in length, etc. The first bargraph segment represents the minimum inductance change necessary for the detector to output a call. Larger inductance changes will be indicated by more segments. Each additional segment represents the next sensitivity level exceeded. Therefore, the bargraph indicates if the sensitivity is set too high or too low, easily facilitating the ideal setting of sensitivity level.

All programmed settings are stored in non-volatile memory and can only be changed by programming new settings. Memory storage consists of an internal EEPROM and an external EEPROM memory module. Settings programmed on either component must match those programmed on the other for the detector to operate. Loss of power or a detector reset will not change the programmed settings. If a loop failure occurs, the LCD will display the type of loop failure as L lo (for -25% change or shorted loop conditions) or L hi (for +25% change or open loop conditions). Each loop failure is counted (up to a maximum of 255 failures) and accumulated in the Loop Failure Memory. Information on the number of failures since the last detector reset or power interruption is very useful during analysis of problems due to intermittent loop operation.

The Model U-1400 detector is a scanning detector. The scanning operation sequentially activates the ON and OFF cycle of each detector channel's oscillator. Because only one channel's input loop(s) is (are) active at a given time, crosstalk between adjacent loops connected to the same scanning detector is minimized. Several Model U-1400 detectors can be linked together via the Synch In and Synch Out lines. This allows loops connected to different detectors to be scanned in series or parallel. When in Program Mode, the Model U-1400 detector displays the real time loop frequency reading for each channel. The eight frequency levels can be incremented or decremented to provide precise frequency settings. This removes the guesswork when changing frequency settings to eliminate crosstalk. NOTE: Adjacent loops connected to different channels of a non-scanning detector or different scanning detectors should be set to different frequencies with the maximum separation possible.

The Reno A&E Model U-1400 uses the first major innovation in inductive loop detectors since the introduction of digital detectors. The programming of all of the detector's parameters with four normally open pushbutton switches not only simplifies setup by removing binary coded rotary or DIP switches, but also increases the reliability of the detector by removing the dependence on switch contacts during normal operation. The detailed descriptions displayed on the LCD eliminate the interpretation of numerous LED flash rates to determine the detector status.

## 2.0 GENERAL CHARACTERISTICS

### 2.1 Loop Frequency

There are eight selectable loop frequency settings (normally in the range of 20 to 100 kilohertz) per loop input. The actual loop operating frequency is a function of the loop / lead-in network and the components of the loop oscillator circuit. The digital display of the actual loop operating frequency for each setting makes it easy to quickly identify and eliminate crosstalk in the most difficult to configure installations. The frequency display is typically very stable when the loop is vacant and vehicles are not passing close to the loops. If the reading is varying by more than  $\pm 1$  in the last digit, this is an indication of possible crosstalk between loops.

### 2.2 Sensitivity

There are ten selectable sensitivity levels per loop input, plus Continuous-Call and Loop-Off. The sensitivity levels are designed so that a one level increase actually doubles the sensitivity and a one level decrease halves the sensitivity. A unique bargraph displayed on the LCD makes it easy to quickly set sensitivity at the ideal level for any loop / lead-in network situation. (See Section 3.4 for actual detection levels at each sensitivity level.)

**CONTINUOUS-CALL:** When set to the Continuous-Call state, the Loop Status is continuously in the Call state regardless of the presence or absence of vehicles over the loop. If the Loop Status Input is assigned to a Vital Output, the Continuous-Call state will deactivate the Vital Output. The loop oscillator is disabled when in the Continuous-Call State. This state is indicated by **CALL** flashing on the LCD. This option can be selected from the Sensitivity menu in Program Mode and is useful for checking controller response and other troubleshooting activities.

**LOOP-OFF:** When set to the Loop-Off state, the Loop Status is continuously in the No-Call state regardless of the presence or absence of vehicles over the loop. If the Loop Status Input is assigned to a Vital Output, the Loop-Off state will not affect the Vital Output. The loop oscillator is disabled when in the Loop-Off State. This state is indicated by **OFF** flashing on the LCD. This option can be selected from the Sensitivity menu in Program Mode and is useful for checking controller response and other troubleshooting activities.

### 2.3 Option 1, Loop Inductance Display

The Loop Inductance Display setting can be toggled ON or OFF by momentarily pressing either the ▲ (UP) or ▼ (DOWN) button. When this option is enabled (ON), the LCD displays the total loop inductance (actual loop inductance plus actual lead-in inductance) in microhenries for loop inductance values in the range of 20 to 2500 microhenries. By recording the inductance of the loop / lead-in circuit when it is first installed, the actual inductance can be compared to the expected inductance to help identify defective loop / lead-in circuits. Loop / lead-in inductance can be easily estimated using the simple formulas included in Section 8.2 of this manual. **NOTE:** Enabling this option activates it for all loop inputs. This option is automatically disabled 15 minutes after activation or on loss of power.

### 2.4 Option 2, Loop Inductance $-\Delta L/L$ Display

The Loop Inductance  $-\Delta L/L$  Display setting can be toggled ON or OFF by momentarily pressing either the ▲ (UP) or ▼ (DOWN) button. When this option is enabled (ON), the LCD displays the percentage of inductance change ( $-\Delta L/L$  value) during the Call state. To facilitate the viewing of the maximum amount of change in the  $-\Delta L/L$  value while traffic is in motion over the detection zone, the channel holds the peak  $-\Delta L/L$  value for a period of two seconds. **NOTE:** Enabling this option activates it for all loop inputs. This option is automatically disabled 15 minutes after activation or on loss of power.

### 2.5 Option 3, Noise Filter

Each loop input's Option 3 has four settings ranging from 3.00 to 3.03. When Option 3 is set to 3.00, the option is disabled (OFF), and normal noise filtering is used. When Option 3 is set to 3.01, 3.02, or 3.03 the option is ON, and increased filtering of the loop signal is used to eliminate problems associated with particular types of noise. Turning this option ON when not required can degrade the performance of the detector. The default setting of Option 3 is 3.00. **This option should only be turned ON at the advice of Reno A&E.** **NOTE:** Each loop can be enabled independently.

3.00 = 250 milliseconds filter.

3.01 = 1 second filter.

3.02 = 2 seconds filter.

3.03 = 10 seconds filter.

## 2.6 Option 4, Detection Zone Tracking

Each loop input's Option 4 has eight settings ranging from 4.00 to 4.07. This option allows the user to select a detection zone tracking setting that will maintain detection zone occupancy for an extended period of time. When Option 4 is set to 4.00, the detector will track out the vehicle (i.e. drop the detection of the vehicle) in four minutes to several hours depending on the amount of inductance change ( $-\Delta L/L$ ) caused by the vehicle when it is detected. The greater the change caused by the vehicle, the longer the time needed to track out the vehicle. When Option 4 is set to 4.01, 4.02, 4.03, 4.04, 4.05, 4.06, or 4.07 the option is ON, and the detector will provide extended detection times. The default setting of Option 4 is 4.02.

There are many factors that influence the proper setting of this option. A full explanation of how to determine the correct setting is beyond the scope of this manual. Contact Technical Support at Reno A & E regarding proper setting of this option.

NOTE: Using this option in a long loop application is not recommended. The detector will drop the call prior to the vehicle totally exiting the loop.

4.00 = Tracking Rate 0.

4.01 = Tracking Rate 1.

4.02 = Tracking Rate 2.

4.03 = Tracking Rate 3.

4.04 = Tracking Rate 4.

4.05 = Tracking Rate 5.

4.06 = Tracking Rate 6.

4.07 = Tracking Rate 7.

## 2.7 Option 5, Sensitivity Boost

Each loop input's Option 5 has five settings ranging from 5.00 to 5.04. When Option 5 is set to 5.00, the option is disabled (OFF), and no sensitivity boost is added. When Option 5 is set to 5.01, 5.02, 5.03, or 5.04 the option is ON, and sensitivity boost is enabled. After detection, the sensitivity is boosted to the currently selected sensitivity level plus the number of level(s) selected. The maximum sensitivity level which can be obtained with or without sensitivity boost is level 10.

5.00 = Off.

5.01 = 1 level.

5.02 = 2 levels.

5.03 = 3 levels.

5.04 = 4 levels.

## 2.8 Option 6, Audible Detect Signal

Each loop input's Audible Detect Signal setting can be toggled ON or OFF by momentarily pressing either the ▲ (UP) or ▼ (DOWN) button. Only one loop input can be turned ON at a time. Turning this option ON for one loop input automatically turns it OFF for the other loop inputs. When this option is enabled (ON), an audible signal will be activated whenever the detection zone for the selected loop input is occupied. The audible signal indicates actual occupancy of the loop detection zone. This feature allows a technician to watch the detection zone and confirm correct detector operation without having to look at the detector display as well. NOTE: This option is automatically disabled 15 minutes after activation or on loss of power.

## 2.9 Loop Check

The Loop Check feature provides a means of automatically verifying the proper operation of each loop circuit. The Loop Check Timer can be set for an interval ranging from 0 to 255 minutes in one-minute increments. A setting of 000 indicates that the Loop Check feature is off.

## 2.10 Detector ID

This feature is used in conjunction with the Synch feature (Option 7) and is also used as a means of providing each detector with a unique identification signature for communication purposes. Detector ID settings can range from 000 to 255. If, however, the detector is set to an ID value of 255, it is considered to be in an uninitialized state and the detector will not save any power down data. When a detector with an ID setting of 255 is powered up, the LCD will alternate between *id* and 255 until the ID setting is changed to something other than 255 and the new setting is saved in detector memory. When any detector is first initialized, its ID setting is, by default, 255.

## 2.11 Option 7, Synch Feature

This option provides a means of linking together up to four (4) U-1400 detectors. Each detector's Option 7 has three settings ranging from 7.00 to 7.02. There are two modes of Synch, Series Synch and Parallel Synch. When set to operate in Series Synch mode, one detector channel in the entire detector system is active at any given time. This has the advantage of minimizing crosstalk between adjacent loops connected to different U-1400 detectors. When set to operate in Parallel Synch mode, all detectors scan their respective channel 1, 2, 3, or 4 inputs at the same time. Parallel Synch offers a faster response time than Series Synch, however the potential for crosstalk is greater.

7.00 = Off.

7.01 = Series Synch.

7.02 = Parallel Synch.

NOTE: When operating in either Series or Parallel Synch mode, all linked detectors must have Option 7 set to the same setting.

## 2.12 Primary Vital Output Delay

Each Primary Vital Output (**Vital Out**) can be conditioned with a Delay time that is adjustable from 0.0 to 25.5 seconds in 0.1-second steps. Primary Vital Output Delay time starts counting down when a Call state is received from a Loop Status Input or Vital Input (**Vital In**) that is mapped to the primary Vital Output (**Vital Out**). When the timer reaches zero, the primary Vital Output is deactivated. Primary Vital Output Delay does not condition the auxiliary Vital Outputs (**Vital Aux**).

## 2.13 Primary Vital Output Extension

Each Primary Vital Output (**Vital Out**) can be conditioned with an Extension time that is adjustable from 0.0 to 25.5 seconds in 0.1-second steps. Primary Vital Output Extension time starts counting down when a Call state is cleared from a Loop Status Input or Vital Input (**Vital In**) that is mapped to the primary Vital Output (**Vital Out**). The primary Vital Output will remain OFF until the Extension time reaches zero. Any vehicle entering the loop detection zone during the Extension time period causes the primary Vital Output to remain in the OFF state, and later, when the last vehicle clears the loop detection zone, the full Primary Vital Output Extension time starts counting down again. Primary Vital Output Extension does not condition the auxiliary Vital Outputs (**Vital Aux**).

## 2.14 Input / Output Mapping

The Loop Status Inputs and/or Vital Inputs (**Vital In**) can be assigned to one or more of the primary Vital (**Vital Out**) and auxiliary Vital (**Vital Aux**) Outputs. Health Status can only be mapped to the auxiliary Vital Outputs (**Vital Aux**).

## 2.15 Full Restore To Factory Default Settings

Pressing all four front panel switches simultaneously and continuously for five (5) seconds resets the detector and restores all the factory default settings. The countdown of the five second period is displayed on the LCD. Releasing any of the switches before the countdown ends aborts the Full Restore operation. (See Default Settings).

NOTE: Resetting the detector to factory default settings will clear any previously mapped output(s).

## 2.16 Diagnostic Features Activation

When the detector is operating in normal mode, pressing either the ▲ (UP) or ▼ (DOWN) button will temporarily activate Option 1 (Loop Inductance Display) and Option 2 (Loop Inductance - $\Delta$ L/L Display) for all loop inputs and Option 6 (Audible Detect Signal) for the loop input indicated in the lower portion of the LCD. All three of these diagnostic options will remain active for 15 minutes.



## 3.0 SPECIFICATIONS

### 3.1 Physical

WEIGHT: 2.73 lb (43.6 oz) (1236 gm).

SIZE: 7.65 inches (19.43 cm) high x 3.90 inches (9.91 cm) wide x 7.13 inches (18.11 cm) deep including connectors.

OPERATING TEMPERATURE: -40°F to +180°F (-40°C to +82°C).

CIRCUIT BOARD: Printed circuit boards are 0.062 inch thick FR4 material with 2 oz. copper on both sides and plated through holes.

CONNECTORS:

PRIMARY INTERFACE CONNECTOR: MS type, 55 Pin, Circular, Male, 71-570128-55M.

PORT 1 SDLC CONNECTOR: DB-15, 15 pin, right angle, PC Board mount, metal shell, D subminiature receptacle with gold plated female contacts and latching blocks.

COMM PORT CONNECTOR: DB-9, nine pin, right angle, PC Board mount, metal shell, D subminiature receptacle with gold plated female contacts and nuts for retaining screws.

### 3.2 Electrical

POWER: 9.5 to 18 VDC, 3.0 Amps maximum.

FUSE: 3 amp, 3AG type (Slo-Blow) type located in a fuse holder mounted on the front panel.

POWER DOWN: When the DC voltage drops below the low power detection threshold (7.9 VDC), the detector will save all needed information to hold calls through the power down sequence. Upon power restoration (a minimum of 9.0 VDC), the detector will use this saved data to determine the correct occupancy state of all loops.

LOOP FEEDER LENGTH: Up to 1500 feet (450 m) maximum with proper feeder cable and appropriate loops.

LOOP INDUCTANCE RANGE: 20 to 2500 microHenries with a Q factor of 5 or greater.

LOOP INPUTS: Transformer isolated. The minimum capacitance added by the detector is 0.068 microFarad.

LIGHTNING PROTECTION: The detector can tolerate, without damage, a 10 microFarad capacitor charged to 2,000 volts being discharged directly into the loop input terminals, or a 10 microFarad capacitor charged to 2,000 volts being discharged between either loop terminal and earth ground.

RESET: Application of a 30 millisecond low state (relative to +12 VDC) to Pin Z of the primary interface connector resets all loops. Each loop input channel can be manually reset by selecting the loop input channel then pressing and holding the front panel CHAN button for three seconds, or by changing the sensitivity or loop frequency of the loop input channel.

SYNCHRONIZE SCAN CONTROL: The SYNCH IN input and SYNCH OUT output allow the loops from different detectors to be scanned sequentially, either in series or parallel. This feature can be used to eliminate crosstalk between adjacent loops connected to different U-1400 detectors. NOTE: Response times will vary depending on the number of detectors (up to a maximum of four) on the SYNCH Line. (See Section 3.4.)

VITAL OUTPUTS: The primary and auxiliary Vital Outputs are transformer isolated and are capable of sourcing 200 mA at 12 VDC. Opto-isolated circuitry verifies that the Vital Output is in the desired state. If any Vital Output fails its self-check, all of the detector's Vital Outputs will be deactivated.

VITAL INPUTS: 12 volt inputs isolated from the detector. Opto-isolated circuitry verifies that the Vital Inputs are operational.

CHECK LOOP RELAYS: Contacts rated for 6.0 Amps maximum, 150 VDC, 300 VAC, and 500 VA maximum switched power.

### 3.3 Operational

LOOP STATUS INDICATORS: Each loop input has a super high intensity red light emitting diode (LED) to indicate a CALL (vehicle detected over loop) or failed loop.

INPUT / OUTPUT INDICATORS: The detector has 12 dual color (green / red) LEDs to indicate the following:

<u>Vital In LED Status</u>	<u>Meaning</u>
OFF	Vital Input is deactivated (low voltage level).
GREEN ON	Vital Input is activated (high voltage level).
RED ON	Vital Input has failed its self-check (Vital Inputs, Primary Vital Outputs, and Auxiliary Vital Outputs revert to OFF state).

<u>Vital Out LED Status</u>	<u>Meaning</u>
OFF	Primary Vital Output is deactivated (low voltage level).
GREEN ON	Primary Vital Output is activated (high voltage level).
GREEN 2Hz FLASHING	Timing Delay activated and Primary Vital Output is working (high voltage level until delay times out).
GREEN 5Hz FLASHING	Timing Extension activated and Primary Vital Output is working (low voltage level until extension times out).
RED ON	Primary Vital Output has failed its self-check (Vital Inputs, Primary Vital Outputs, and Auxiliary Vital Outputs revert to OFF state).

<u>Vital Aux LED Status</u>	<u>Meaning</u>
OFF	Auxiliary Vital Output is deactivated (low voltage level).
GREEN ON	Auxiliary Vital Output is activated (high voltage level).
RED ON	Auxiliary Vital Output has failed its self-check (Vital Inputs, Primary Vital Outputs, and Auxiliary Vital Outputs revert to OFF state).

RESPONSE TIME: See Section 3.4 for actual response times.

SELF-TUNING: Each loop circuit tunes and is operational within two seconds after application of power or after being reset. Full sensitivity and hold time require 30 seconds of operation.

ENVIRONMENTAL & TRACKING: The detector is fully self-compensating for environmental changes and loop drift over the full temperature range and the entire loop inductance range.

GROUNDING LOOP OPERATION: The loop isolation transformer allows operation with poor quality loops (which may include one short to ground at a single point).

LOOP (FAIL) MONITOR: If the total inductance of a channel's loop input network goes out of the range specified for the detector, or rapidly changes by more than  $\pm 25\%$ , and the Loop and/or Health status outputs are mapped, the Loop and/or Health status outputs will immediately enter Fail-Safe mode and the LCD will display **LOOP FAIL**. The type of loop failure will also be displayed as **L lo** (for -25% change or shorted loop conditions) or **L hi** (for +25% change or open loop conditions). This will continue as long as the loop fault exists. At the time of a loop failure, the Loop status LED will begin to flash at a rate of three flashes per second. The LED will continue this display pattern until the loop input channel is manually reset or power is removed. If the loop self-heals, the **LOOP FAIL** message on the LCD will extinguish and the loop input channel will resume operation in a normal manner; except the Loop status LED will continue the three flashes per second display pattern, thus providing an alert that a prior Loop Fail condition has occurred. Each loop failure for the loop input channel is counted and accumulated into the Loop Fail Memory. The total number of loop failures written into the Loop Fail Memory (since the last power interruption or manual reset) can be seen by stepping through the loop input channel's detector functions in Program Mode to the **LOOP FAIL** message. When the status of one or more loops is assigned to a Vital Output, a loop failure will deactivate the Vital Output and the corresponding **Vital Out** LED will turn from green to OFF to indicate the failure. When a Health Status is assigned to an auxiliary Vital Output, a loop failure will deactivate the auxiliary Vital Output and the corresponding **Vital Aux** LED will turn off.

LOOP CHECK: This feature is used as a means of verifying proper operation of each inductive loop connected to a detector. In a typical installation, a separate loop of wire called a check loop will be wound around the perimeter of each inductive loop. The Loop Check Timer can be programmed with a value ranging from 1 to 255 minutes. Once this time interval has elapsed, the detector will automatically short the check loop simulating vehicle detection in the inductive loop. If this initial loop check test fails, the detector will enter a verification mode to make certain that the loop failure is indeed due to a loop related problem. While operating in this verification mode, the detector will perform a series of ten verification tests and the LCD will flash **PcI**. If the ten loop check verification tests all fail, the Vital Output(s) to which the Loop Status Input(s) and/or Health Status Input(s) is (are) mapped will be deactivated. The loop check test will be repeated at regular intervals depending on the value programmed into the

Loop Check Timer. The Vital Output(s) to which the Loop Status Input(s) and/or Health Status Input(s) is (are) mapped will not be activated until the problem with the check loop is corrected and the channel reset or until the Loop Check function is turned off. During a check loop failure the LCD will flash **Lcl**. NOTE: If the Loop Check Timer is set to 0 minutes, the Loop Check function is off.

SYNCH MODE: The Synch feature provides a means of linking up to four U-1400 detectors together. There are two modes in which the detectors can be configured to operate; Series Synch or Parallel Synch.

Series Synch mode can be used to eliminate the possibility of crosstalk between adjacent loops. Series Synch will activate one loop at a time, cycling through all loops configured to detect in the Series Synch mode. When the detector system is configured to operate in Series Synch mode, it is necessary for one detector to be identified as the master unit, i.e. the detector that starts the Synch pulse. This master unit must be assigned a Detector ID value of 000. The scanning sequence of detector loop input channels is Detector ID 000 channel 1, Detector ID 000 channel 2, Detector ID 000 channel 3, Detector ID 000 channel 4, second detector channel 1, second detector channel 2, second detector channel 3, second detector channel 4, and so on until the synch pulse returns to the first detector. The Synch-out of the first (master) unit is connected to the Synch-in of the second detector; the Synch-out of the second detector is connected to the Synch-in of the third detector. This connection scheme is continued until the Synch-out of the last detector is connected to the Synch in of the first (master) detector.

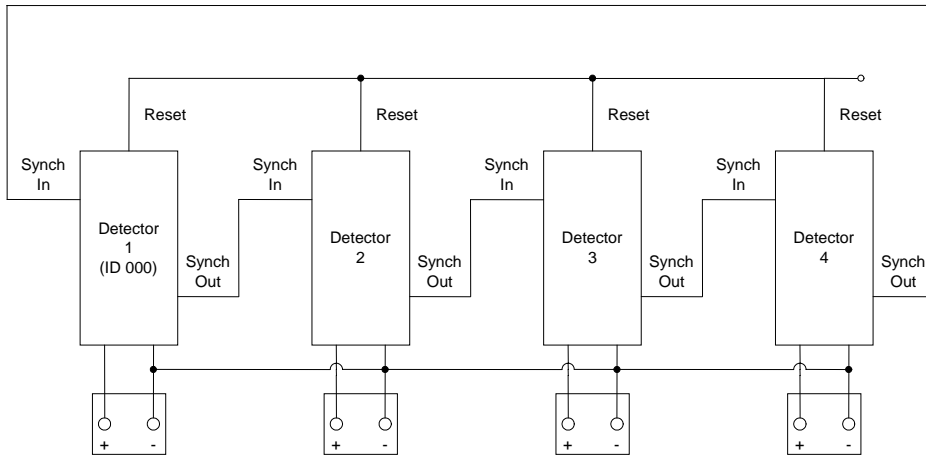

Series Synch Connections

When set to operate in Parallel Synch mode, all detectors configured to operate in Parallel Synch mode start scanning their respective channel 1 loop inputs at the same time and then proceed to sequentially scan their respective channel 2, 3, and 4 loop inputs. When the detector system is configured to operate in Parallel Synch mode, it is necessary for one detector to be identified as the master unit. This master unit must be assigned a Detector ID value of 000. Connections between detectors differ from those in Series Synch mode in that the Synch-out of first detector is connected to the Synch-in of the other detectors and the Synch-in of the first detector is connected to the Synch-out of the other detectors.

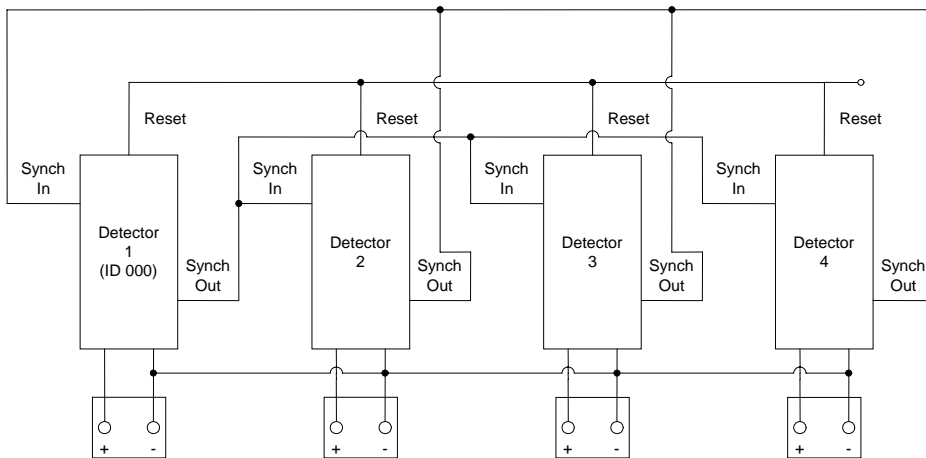

Parallel Synch Connections

Operation in either Synch mode requires that the Reset inputs (pin Z of the primary interface connector) of all detectors be tied together and that the DC Common inputs (pin G of the primary interface connector) of all detectors be tied together. To start operation in either Synch mode, the detectors must be reset using the Reset pin (pin Z of the primary interface connector).

When operating in Series Synch mode, if any detector fails to Synch, all of the Vital Outputs of every detector configured to operate in Synch mode will be deactivated. If the detector that has failed to Synch has the Synch feature turned off, the other detectors configured to operate in Synch mode will continue to operate in Series Synch mode.

When operating in Parallel Synch mode, if the master unit fails, all of the Vital Outputs of every detector configured to operate in Synch mode will be deactivated. If one or more of the detectors connected to the master unit Fails, only those Vital Outputs of the detector(s) which has (have) failed will be deactivated.

When operating in either Series or Parallel mode, *FSY* will be displayed on the LCD screen of the detector(s) associated with the failure. This display state will continue until the problem is corrected and the detectors are powered down and repowered, reset, or until the Synch function is turned off.

In either mode of operation, the Synch feature will continue to function if one or more detectors has (have) been disabled.

**3.4 TABLE: Sensitivity,  $-\Delta L/L$ , & Response Time**

Sensitivity	$-\Delta L/L$	Response Time (milliseconds)						
		One Detector	Two Detectors		Three Detectors		Four Detectors	
			Series Synch	Parallel Synch	Series Synch	Parallel Synch	Series Synch	Parallel Synch
OFF	-----	-----	-----	-----	-----	-----	-----	-----
1	5.12 %	121 ±25	268 ±52	278 ±58	400 ±80	278 ±58	530 ±110	278 ±58
2	2.56 %	121 ±25	268 ±52	278 ±58	400 ±80	278 ±58	530 ±110	278 ±58
3	1.28 %	121 ±25	268 ±52	278 ±58	400 ±80	278 ±58	530 ±110	278 ±58
4	0.64 %	121 ±25	268 ±52	278 ±58	400 ±80	278 ±58	530 ±110	278 ±58
5	0.32 %	121 ±25	268 ±52	278 ±58	400 ±80	278 ±58	530 ±110	278 ±58
6	0.16 %	121 ±25	268 ±52	278 ±58	400 ±80	278 ±58	530 ±110	278 ±58
7	0.08 %	121 ±25	268 ±52	278 ±58	400 ±80	278 ±58	530 ±110	278 ±58
8	0.04 %	121 ±25	268 ±52	278 ±58	400 ±80	278 ±58	530 ±110	278 ±58
9	0.02 %	121 ±25	268 ±52	278 ±58	400 ±80	278 ±58	530 ±110	278 ±58
10	0.01 %	121 ±25	268 ±52	278 ±58	400 ±80	278 ±58	530 ±110	278 ±58
CALL	-----	-----	-----	-----	-----	-----	-----	-----

### 3.5 TABLES: Default Settings

#### CHANNEL & DETECTOR SETTINGS:

Function	Channel 1	Channel 2	Channel 3	Channel 4
Frequency	2	4	6	8
Sensitivity	6	6	6	6
Option 1 - Loop Inductance Display	OFF	OFF	OFF	OFF
Option 2 - Loop Inductance - $\Delta L/L(\%)$ Display	OFF	OFF	OFF	OFF
Option 3 - Noise Filter	3.00	3.00	3.00	3.00
Option 4 - Detection Zone Tracking	4.02	4.02	4.02	4.02
Option 5 - Sensitivity Boost	5.00	5.00	5.00	5.00
Option 6 - Audible Detect Signal	OFF	OFF	OFF	OFF
Loop Check Feature	005	005	005	005
Detector ID Setting	255			
Option 7 - Synch Feature	7.00			

#### VITAL OUTPUT SETTINGS:

Function	Output 1	Output 2	Output 3	Output 4
Primary Vital Output Delay Time	00.0	00.0	00.0	00.0
Primary Vital Output Extension Time	00.0	00.0	00.0	00.0
Primary Vital Output Mapping	00	00	00	00
Auxiliary Vital Output Mapping	000	000	000	000

### 3.6 TABLES: Pin Assignments

#### PRIMARY INTERFACE CONNECTOR

##### SEQUENTIAL PIN ASSIGNMENTS

Pin	Function	Pin	Function
A	Channel 1 Primary Vital Output -	f	Channel 3 Primary Vital Output +
B	Channel 1 Vital Input -	g	Channel 4 Primary Vital Output -
C	Channel 2 Vital Input +	h	Channel 4 Primary Vital Output +
D	Channel 3 Loop Input	i	Channel 2 Check Loop Input
E	Channel 3 Loop Input	j	Channel 3 Check Loop Input
F	Channel 4 Loop Input	k	Channel 2 Auxiliary Vital Output -
G	DC Common (Non-isolated)	m	Channel 2 Primary Vital Output -
H	12 VDC + (Non-isolated)	n	Channel 1 Auxiliary Vital Output +
J	Channel 4 Auxiliary Vital Output -	p	Channel 1 Auxiliary Vital Output -
K	Channel 3 Primary Vital Output -	q	Channel 1 Vital Input +
L	Channel 3 Auxiliary Vital Output +	r	Channel 4 Vital Input +
M	Channel 3 Auxiliary Vital Output -	s	Channel 4 Vital Input -
N	Channel 1 Check Loop Input	t	Reserved
P	Channel 2 Check Loop Input	u	Channel 1 Check Loop Input
R	Channel 3 Check Loop Input	v	Channel 4 Check Loop Input
S	Channel 1 Loop Input	w	Reserved
T	Channel 1 Loop Input	x	Reserved
U	Channel 2 Loop Input	y	Channel 3 Vital Input +
V	Channel 2 Loop Input	z	Channel 2 Auxiliary Vital Output +
W	Channel 2 Vital Input -	AA	No Connection
X	Synch In	BB	Channel 2 Primary Vital Output +
Y	Channel 3 Vital Input -	CC	No Connection
Z	Reset	DD	No Connection
a	Reserved	EE	Chassis Ground
b	Channel 4 Loop Input	FF	Channel 1 Primary Vital Output +
c	Synch Out	GG	No Connection
d	Channel 4 Check Loop Input	HH	No Connection
e	Channel 4 Auxiliary Vital Output +		

## PRIMARY INTERFACE CONNECTOR

### FUNCTIONAL PIN ASSIGNMENTS

Pin	Function	Pin	Function
H	12 VDC + (Non-isolated)	m	Channel 2 Primary Vital Output -
n	Channel 1 Auxiliary Vital Output +	f	Channel 3 Primary Vital Output +
p	Channel 1 Auxiliary Vital Output -	K	Channel 3 Primary Vital Output -
z	Channel 2 Auxiliary Vital Output +	h	Channel 4 Primary Vital Output +
k	Channel 2 Auxiliary Vital Output -	g	Channel 4 Primary Vital Output -
L	Channel 3 Auxiliary Vital Output +	q	Channel 1 Vital Input +
M	Channel 3 Auxiliary Vital Output -	B	Channel 1 Vital Input -
e	Channel 4 Auxiliary Vital Output +	C	Channel 2 Vital Input +
J	Channel 4 Auxiliary Vital Output -	W	Channel 2 Vital Input -
N	Channel 1 Check Loop Input	y	Channel 3 Vital Input +
u	Channel 1 Check Loop Input	Y	Channel 3 Vital Input -
P	Channel 2 Check Loop Input	r	Channel 4 Vital Input +
i	Channel 2 Check Loop Input	s	Channel 4 Vital Input -
R	Channel 3 Check Loop Input	EE	Chassis Ground
j	Channel 3 Check Loop Input	G	DC Common (Non-isolated)
d	Channel 4 Check Loop Input	Z	Reset
v	Channel 4 Check Loop Input	X	Synch In
S	Channel 1 Loop Input	c	Synch Out
T	Channel 1 Loop Input	AA	No Connection
U	Channel 2 Loop Input	CC	No Connection
V	Channel 2 Loop Input	DD	No Connection
D	Channel 3 Loop Input	GG	No Connection
E	Channel 3 Loop Input	HH	No Connection
F	Channel 4 Loop Input	a	Reserved
b	Channel 4 Loop Input	t	Reserved
FF	Channel 1 Primary Vital Output +	w	Reserved
A	Channel 1 Primary Vital Output -	x	Reserved
BB	Channel 2 Primary Vital Output +		

**AUX PORT (DB-15 External EEPROM Connector)**

Pin	Function
1	No Connection
2	No Connection
3	No Connection
4	No Connection
5	No Connection
6	No Connection
7	I <sup>2</sup> C DC +
8	I <sup>2</sup> C Clock
9	No Connection
10	No Connection
11	No Connection
12	No Connection
13	No Connection
14	I <sup>2</sup> C Common
15	I <sup>2</sup> C Data

**COMM PORT (DB-9 Communication Interface Connector)**

Pin	Function
1	No Connection
2	RS-232 TX
3	RS-232 RX
4	No Connection
5	RS-232 Common
6	No Connection
7	No Connection
8	No Connection
9	No Connection



**3.7 TABLE: Pin Assignments / Wire Colors**

**MODEL 805-3-S & MODEL 805-8-S WIRING HARNESS**

Pin	Function	Wire Color	Pin	Function	Wire Color
A	Channel 1 Primary Vital Output -	Brown / Blue	f	Channel 3 Primary Vital Output +	Blue / Orange
B	Channel 1 Vital Input -	Brown / Gray	g	Channel 4 Primary Vital Output -	Yellow / Blue
C	Channel 2 Vital Input +	Gray / Red	h	Channel 4 Primary Vital Output +	Blue / Yellow
D	Channel 3 Loop Input	Orange	i	Channel 2 Check Loop Input	White
E	Channel 3 Loop Input	Orange	j	Channel 3 Check Loop Input	White
F	Channel 4 Loop Input	Yellow	k	Channel 2 Auxiliary Vital Output -	Red / Violet
G	DC Common (Non-isolated)	Black	m	Channel 2 Primary Vital Output -	Red / Blue
H	12 VDC + (Non-isolated)	Red / White	n	Channel 1 Auxiliary Vital Output +	Violet / Brown
J	Channel 4 Auxiliary Vital Output -	Yellow / Violet	p	Channel 1 Auxiliary Vital Output -	Brown / Violet
K	Channel 3 Primary Vital Output -	Orange / Blue	q	Channel 1 Vital Input +	Gray / Brown
L	Channel 3 Auxiliary Vital Output +	Violet / Orange	r	Channel 4 Vital Input +	Gray / Yellow
M	Channel 3 Auxiliary Vital Output -	Orange / Violet	s	Channel 4 Vital Input -	Yellow / Gray
N	Channel 1 Check Loop Input	White	t	Reserved	N/A
P	Channel 2 Check Loop Input	Red	u	Channel 1 Check Loop Input	Brown
R	Channel 3 Check Loop Input	Orange	v	Channel 4 Check Loop Input	White
S	Channel 1 Loop Input	Brown	w	Reserved	N/A
T	Channel 1 Loop Input	Brown	x	Reserved	N/A
U	Channel 2 Loop Input	Red	y	Channel 3 Vital Input +	Gray / Orange
V	Channel 2 Loop Input	Red	z	Channel 2 Auxiliary Vital Output +	Violet / Red
W	Channel 2 Vital Input -	Red / Gray	AA	No Connection	N/A
X	Synch In	Blue	BB	Channel 2 Primary Vital Output +	Blue / Red
Y	Channel 3 Vital Input -	Orange / Gray	CC	No Connection	N/A
Z	Reset	Gray	DD	No Connection	N/A
a	Reserved	N/A	EE	Chassis Ground	Green
b	Channel 4 Loop Input	Yellow	FF	Channel 1 Primary Vital Output +	Blue / Brown
c	Synch Out	Violet	GG	No Connection	N/A
d	Channel 4 Check Loop Input	Yellow	HH	No Connection	N/A
e	Channel 4 Auxiliary Vital Output +	Violet / Yellow			

NOTES: The pairs of wires connected to Pins D & E, Pins F & b, Pins N & u, Pins P & i, Pins R & j, Pins S & T, Pins U & V, and Pins d & v are twisted together.

There is an additional green wire in the harness wire bundle that is used to ground the connector shell.

## 4.0 USER INTERFACE

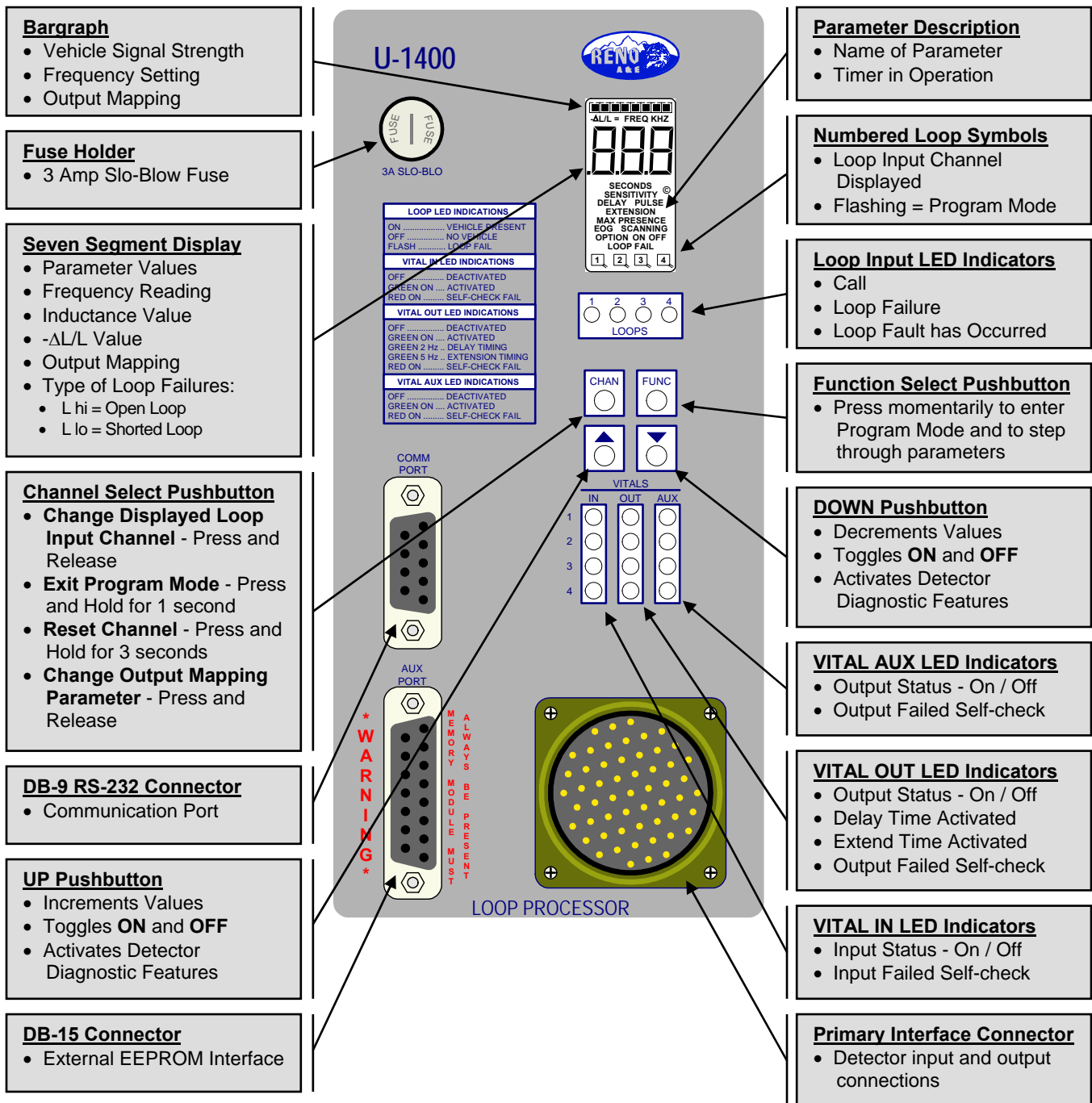

NOTES: The LCD backlighting illuminates whenever any pushbutton is pressed. Backlighting will extinguish 15 minutes after the last pushbutton press.

Pressing any two or three pushbuttons illuminates the LCD backlighting, displays all LCD segments, and illuminates the Vital In, Vital Out, and Vital Aux Output LEDs. The Output LEDs are illuminated in their red phase as a means of confirming proper function of the detector's Vital Output failure feature.

## 5.0 INSTALLATION AND SET-UP

The detector has no DIP switches or jumpers to configure. In order for the detector to operate, the external EEPROM memory module shipped with the detector **MUST** be connected to the DB-15 Aux Port connector on the front panel. Connect an appropriately wired harness to the 55 pin Primary Interface Connector on the front panel and apply power to the detector. If the detector is not new from the factory, it may be advantageous to reset the detector back to the factory defaults to avoid having to check every setting for every loop input channel. To reset the detector to factory default, press all four pushbutton switches simultaneously for five seconds. When all four buttons are depressed, the display will start counting down from five (5). When the countdown reaches zero (0), releasing the pushbuttons will reload the factory defaults and reset all loop input channels. NOTE: Resetting the detector to factory default settings will clear any previously mapped output(s).

All operating parameters can be adjusted from the front panel. The detector continues to operate normally while it is in the Program Mode. The value currently displayed is always the actual value being used. Example: If you are changing the delay time, the time displayed at the instant that a vehicle entered the detection zone for that loop input channel would be the value used for the delay timer.

Pressing the FUNC button enters the Program Mode. The FUNC button has an auto repeat function. This allows quick navigation to the desired parameter. The FUNC button only moves forward through all of the parameters. There is no way to move backwards through the parameters.

While viewing any parameter, pressing the CHAN button will display the same parameter in the next loop input channel. The currently selected channel is indicated at the bottom of the LCD display. Pressing and holding the CHAN button for one second will exit the Program Mode and return to the Normal Mode.

Pressing and holding either the ▲ (UP) or ▼ (DOWN) button will cause the value to change rapidly until the button is released.

## 5.1 Initial Installation Start-up Mode Display Screens



Upon application of power, the LCD screen will show the detector model letter and firmware version, in this case, Model U-1400 firmware version 3. This screen will be displayed for two seconds.

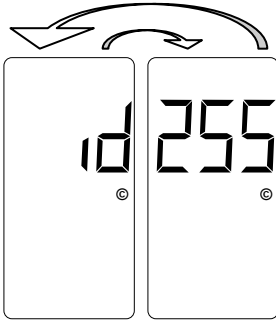

The next LCD screens displayed will show the Detector ID setting. The display will toggle between the two screens shown with a 50% duty cycle. When shipped from the factory, the Detector ID is set to 255 and the detector is considered to be uninitialized. This will be the case on initial start-up. Before proceeding, the detector ID must be changed to something other than 255. To do so, use the ▲ (UP) or ▼ (DOWN) button to change the setting to the desired ID number. When set to the correct value, press the FUNC button to accept and store the setting. If the detector in question is being used as the master unit when utilizing the Synch feature, the Detector must be assigned an ID value of 000.



The detector will next confirm the state of the check loops connected to it. If all four check loops are connected and are intact, the LCD screen will display an indication of the successful completion of the check loop verification. This screen will flash twice.

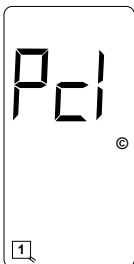

If all four check loops are not connected or one (or more) is (are) damaged in some way, the detector will initiate its check loop verification process. The LCD screen will display an indication of a pending state during the check loop verification. This screen will flash for 55 seconds until one of three things happen; the check loop verification fails, the check loop(s) causing the check loop verification is (are) connected or restored to a functional state, or the check loop(s) causing the check loop verification is (are) turned off, i.e. the Loop Check Timer of the loop(s) is set to 000.

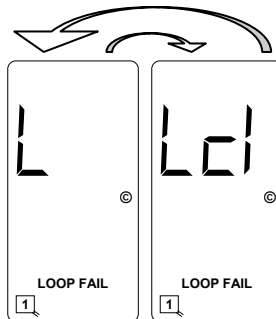

If the check loop verification process continues for the entire 55 second period and no action has been taken to connect or restore the check loops causing the check loop verification, the LCD screen will toggle between the two screens shown with a 50% duty cycle.



If the detector passes its check loop verification process or a pending loop check failure state is resolved in one of the ways mentioned above, the LCD screen will show a normal (idle) condition.

## 5.2 Program Mode Display Screens



**PARAMETER** ..... Frequency.  
**SETTINGS** ..... Eight selections - 1 to 8.  
**SETTING DISPLAYED** ..... Bargraph indicates settings from 1 (left) to 8 (right).  
**7-SEGMENT DISPLAY** ..... Actual frequency of the loop circuit. Typically 20.0 to 99.9 kiloHertz.  
**DEFAULT SETTINGS** ..... Loop Input 1 = 2, Loop Input 2 = 4, Loop Input 3 = 6, and Loop Input 4 = 8.  
**EXAMPLE** ..... Frequency setting 4 is selected for loop input. The loop frequency is 34.9 kHz.  
**NOTES** ..... Changing the frequency will reset the Loop Input. An unstable frequency display varying more than  $\pm 0.2$  kiloHertz may indicate loop crosstalk or other interference.

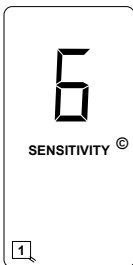

**PARAMETER** ..... Sensitivity.  
**SETTINGS** ..... 12 selections - 1 to 10, OFF, or CALL.  
**SETTING DISPLAYED** ..... 7-segment display will show currently selected setting.  
**7-SEGMENT DISPLAY** ..... Currently selected Sensitivity.  
**DEFAULT SETTING** ..... 6 for all loop inputs.  
**EXAMPLE** ..... Sensitivity 6 is selected for loop input 1.  
**NOTES** ..... Changing the sensitivity will reset the loop input. The bargraph will show strength of vehicle calls so that correct sensitivity can be verified from this screen.

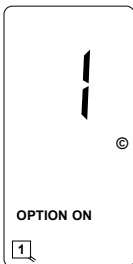

**PARAMETER** ..... Option 1 (Loop/Lead-In Inductance Display).  
**SETTINGS** ..... ON or OFF.  
**SETTING DISPLAYED** ..... The word ON or OFF will be displayed.  
**7-SEGMENT DISPLAY** ..... The number of this option.  
**DEFAULT SETTING** ..... OFF for all loop inputs.  
**EXAMPLE** ..... Option 1 is turned ON for all loop inputs.  
**NOTES** ..... This option is a detector-wide setting. Changing it for one loop input changes it for all loop inputs. This option will automatically turn off in 15 minutes.

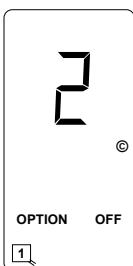

**PARAMETER** ..... Option 2 (Percentage of Inductance change,  $-\Delta L/L$ ).  
**SETTINGS** ..... ON or OFF.  
**SETTING DISPLAYED** ..... The word ON or OFF will be displayed.  
**7-SEGMENT DISPLAY** ..... The number of this option.  
**DEFAULT SETTING** ..... OFF for all loop inputs.  
**EXAMPLE** ..... Option 2 is turned OFF for all loop inputs.  
**NOTES** ..... This option is a detector-wide setting. Changing it for one loop input changes it for all loop inputs. This option will automatically turn off in 15 minutes.



**PARAMETER** ..... Option 3 (Noise Filter).  
**SETTINGS** ..... Four selections - 3.00 to 3.03.  
**SETTING DISPLAYED** ..... The word ON or OFF will be displayed.  
**7-SEGMENT DISPLAY** ..... The number of this option.  
**DEFAULT SETTING** ..... 3.00 (OFF) for all loop inputs.  
**EXAMPLE** ..... Option 3.02 is turned ON for loop input 1.  
**NOTES** ..... This option is a channel specific setting. Changing it for one loop input changes it for that loop input only. **It is strongly recommended that this option be set to 3.00 (OFF) for normal operation.**



**PARAMETER** ..... Option 4 (Detection Zone Tracking).  
**SETTINGS** ..... Eight selections - 4.00 to 4.07.  
**SETTING DISPLAYED** ..... The word ON or OFF will be displayed.  
**7-SEGMENT DISPLAY** ..... The number of this option.  
**DEFAULT SETTING** ..... 4.02 (ON) for all loop inputs.  
**EXAMPLE** ..... Option 4.03 is turned ON for loop input 1.  
**NOTES** ..... This option is a loop input specific setting. Changing it for one loop input changes it for that loop input only.



**PARAMETER** ..... Option 5 (Sensitivity Boost).  
**SETTINGS** ..... Five selections - 5.00 to 5.04.  
**SETTING DISPLAYED** ..... The word ON or OFF will be displayed.  
**7-SEGMENT DISPLAY** ..... The number of this option.  
**DEFAULT SETTING** ..... 5.00 (OFF) for all loop inputs.  
**EXAMPLE** ..... Option 5.04 is turned ON for loop input 1.  
**NOTES** ..... This option is a loop input specific setting. Changing it for one loop input changes it for that loop input only.

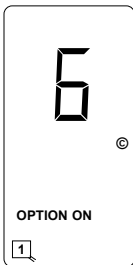

**PARAMETER** ..... Option 6 (Audible Detect).  
**SETTINGS** ..... ON or OFF.  
**SETTING DISPLAYED** ..... The word ON or OFF will be displayed.  
**7-SEGMENT DISPLAY** ..... The number of this option.  
**DEFAULT SETTING** ..... OFF for all loop inputs.  
**EXAMPLE** ..... Option 6 is turned ON for loop input 1.  
**NOTES** ..... This option is mutually exclusive with the same option in any other loop input. Turning it on for one loop input turns it off for all other loop inputs. This option will automatically turn off after 15 minutes.



**PARAMETER** ..... Loop Check Timer setting.  
**SETTINGS** ..... 256 selections - 000 to 255 minutes in 1 minute steps.  
**SETTING DISPLAYED** ..... 7-segment display will show currently selected setting.  
**7-SEGMENT DISPLAY** ..... Currently selected time in minutes.  
**DEFAULT SETTING** ..... Five minutes (005) for all loop inputs.  
**EXAMPLE** ..... The Loop Check Timer for Loop 1 is set for 25 minutes.  
**NOTES** ..... This option is a loop input specific setting. Changing it for one loop input changes it for that loop input only.

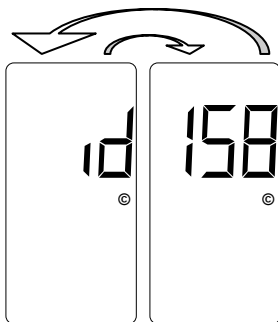

**PARAMETER** ..... Detector ID setting.  
**SETTINGS** ..... 256 selections - 000 to 255.  
**SETTING DISPLAYED** ..... 7-segment display will show currently selected setting.  
**7-SEGMENT DISPLAY** ..... Current Detector ID setting. The display will toggle between the two screens with a 50% duty cycle.  
**DEFAULT SETTING** ..... 255.  
**EXAMPLE** ..... Detector ID is set as 158.  
**NOTES** ..... When set to Detector ID number 255, the detector is considered uninitialized.



**PARAMETER** ..... Option 7 (Synch Feature).  
**SETTINGS** ..... Three selections - 7.00 to 7.02.  
**SETTING DISPLAYED** ..... The word ON or OFF will be displayed.  
**7-SEGMENT DISPLAY** ..... The number of this option.  
**DEFAULT SETTING** ..... 7.00 (OFF) for all loop inputs.  
**EXAMPLE** ..... Option 7 is turned OFF.  
**NOTES** ..... This option is a detector-wide setting. Setting Option 7 to 7.01 activates Series Synch (SYS), setting Option 7 to 7.02 activates Parallel Synch (SYP).



**PARAMETER** ..... Primary Vital Output Delay.  
**SETTINGS** ..... 256 selections - 00.0 to 25.5 Seconds in 0.1 second steps.  
**SETTING DISPLAYED** ..... 7-segment display will show currently selected setting. Loop symbol indicates which Primary Vital Output the Delay time applies to.  
**7-SEGMENT DISPLAY** ..... Currently selected Delay time in seconds.  
**DEFAULT SETTING** ..... 00.0 seconds.  
**EXAMPLE** ..... Delay of 10 seconds selected for Primary Vital Output 1.  
**NOTES** ..... If the loop input's detection zone is occupied when this parameter is changed, it will not take effect until the detection zone is empty or the loop input is reset. When viewing and/or setting the Primary Vital Output Delay time settings, use the CHAN button to advance to the Delay time settings of the next Primary Vital Output.



**PARAMETER** ..... Primary Vital Output Extension.  
**SETTINGS** ..... 256 selections - 00.0 to 25.5 Seconds in 0.1 second steps.  
**SETTING DISPLAYED** ..... 7-segment display will show currently selected setting. Loop symbol indicates which Primary Vital Output the Extension time applies to.  
**7-SEGMENT DISPLAY** ..... Currently selected Extension time in seconds.  
**DEFAULT SETTING** ..... 00.0 seconds.  
**EXAMPLE** ..... Extension of 2.5 seconds selected for Primary Vital Output 1.  
**NOTES** ..... If the loop input's detection zone is occupied when this parameter is changed, it will not take effect until the detection zone is empty or the loop input is reset. When viewing and/or setting the Primary Vital Output Extension time settings, use the CHAN button to advance to the Extension time settings of the next Primary Vital Output.

### 5.2.1 Primary Vital Output (*Vital Out*) Mapping Screens

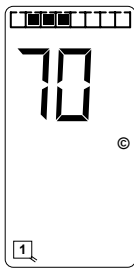

- PARAMETER** ..... Primary Vital Output (*Vital Out*) Mapping.
- SETTINGS** ..... 256 selections - any and all combinations of the four Loop Status Inputs and the four Vital Inputs (*Vital In*).
- SETTING DISPLAYED**..... Bargraph indicates Loop Status Inputs and/or Vital Inputs mapped to the Primary Vital Outputs. In Loop Status Input mode, the leftmost segment = Loop Status Input 4, next segment = Loop Status Input 3, next segment = Loop Status Input 2, next segment = Loop Status Input 1. In Vital Input mode, the center four segments are used. The leftmost center segment = Vital Input 4, next segment = Vital Input 3, next segment = Vital Input 2, next segment = Vital Input 1. The loop symbol indicates which Primary Vital Output the Loop Status Inputs and/or Vital Inputs are being mapped to.
- 7-SEGMENT DISPLAY** ..... 7-segment display will show currently selected setting. The first character corresponds to the Loop Status Inputs mapped to the Primary Vital Outputs, the second character corresponds to the Vital Inputs mapped to the Primary Vital Outputs.
- DEFAULT SETTINGS**..... Primary Vital Output 1 = 00. No Loop Status Inputs mapped to Primary Vital Output 1. No Vital Inputs mapped to Primary Vital Output 1.  
 Primary Vital Output 2 = 00. No Loop Status Inputs mapped to Primary Vital Output 2. No Vital Inputs mapped to Primary Vital Output 2.  
 Primary Vital Output 3 = 00. No Loop Status Inputs mapped to Primary Vital Output 3. No Vital Inputs mapped to Primary Vital Output 3.  
 Primary Vital Output 4 = 00. No Loop Status Inputs mapped to Primary Vital Output 4. No Vital Inputs mapped to Primary Vital Output 4.
- EXAMPLE** ..... Loop Status Inputs 1, 2, & 3 mapped to Primary Vital Output 1. No Vital Inputs mapped to Primary Vital Output 1.
- NOTES** ..... The characters are displayed in Hexadecimal notation (Base 16).  
 When viewing and/or setting the Primary Vital Output mapping settings, use the FUNC button to advance to the mapping settings of the next Primary Vital Output.  
 A Primary Vital Output is deactivated if no Loop Status Inputs or Vital Inputs are mapped to it.



To set the mapping status of the Loop Status Inputs, repeatedly press the FUNC button to enter Program Mode and toggle through the set-up parameters until the display screen shows the bargraph and two of the seven-segment display characters. The left character and a loop symbol will flash indicating the current setting and the four leftmost bargraph segments will show the corresponding Loop Status Input mapping. Use the ▲ (UP) or ▼ (DOWN) button to change the setting to the desired configuration. Use the FUNC button to advance to the next Primary Vital Output (indicated by a flashing numbered loop symbol at the bottom of the LCD screen). The various combinations of display characters and bargraph display are shown below.

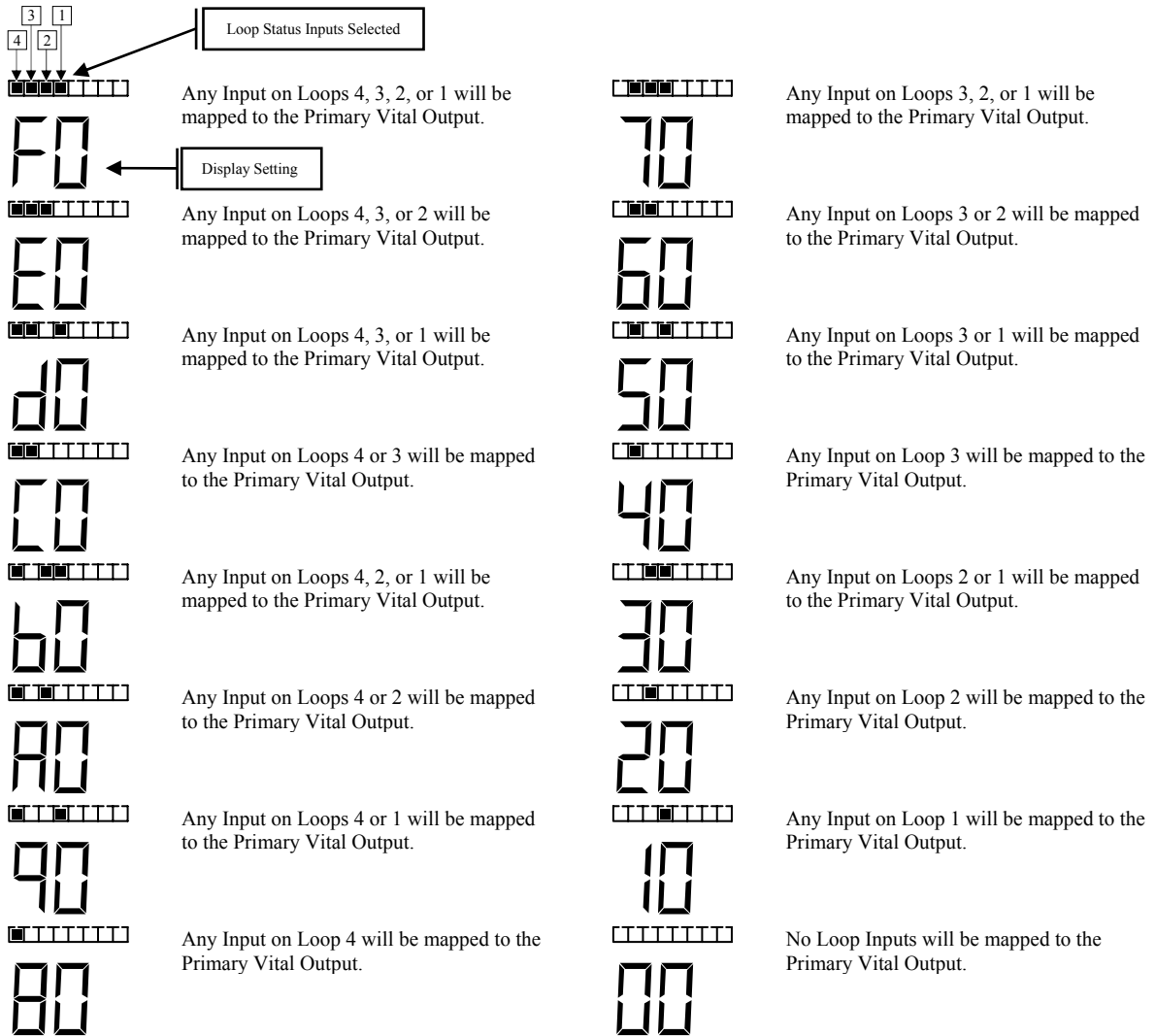

To set the mapping status of the Vital Inputs when in the Primary Vital Output Mapping Program Mode, press the CHAN button once. The right character and a loop symbol will flash indicating the current setting and the center four bargraph segments will show the corresponding Vital Inputs mapping. Use the ▲ (UP) or ▼ (DOWN) button to change the setting to the desired configuration. Use the FUNC button to advance to the next Primary Vital Output (indicated by a flashing numbered loop symbol at the bottom of the LCD screen). The various combinations of display characters and bargraph display are shown below.

When in Normal Mode, repeatedly press the FUNC button to enter Program Mode and toggle through the set-up parameters until the display screen shows the bargraph and two of the seven-segment display characters. The left character and a loop symbol will flash indicating the current setting and the four leftmost bargraph segments will show the corresponding Loop Status Input mapping. Press the CHAN button once. The right character and a loop symbol will flash indicating the current setting and the center four bargraph segments will show the corresponding Vital Inputs mapping. Use the ▲ (UP) or ▼ (DOWN) button to change the setting to the desired configuration. Use the FUNC button to advance to the next Primary Vital Output (indicated by a flashing numbered loop symbol at the bottom of the LCD screen). The various combinations of display characters and bargraph display are shown below.

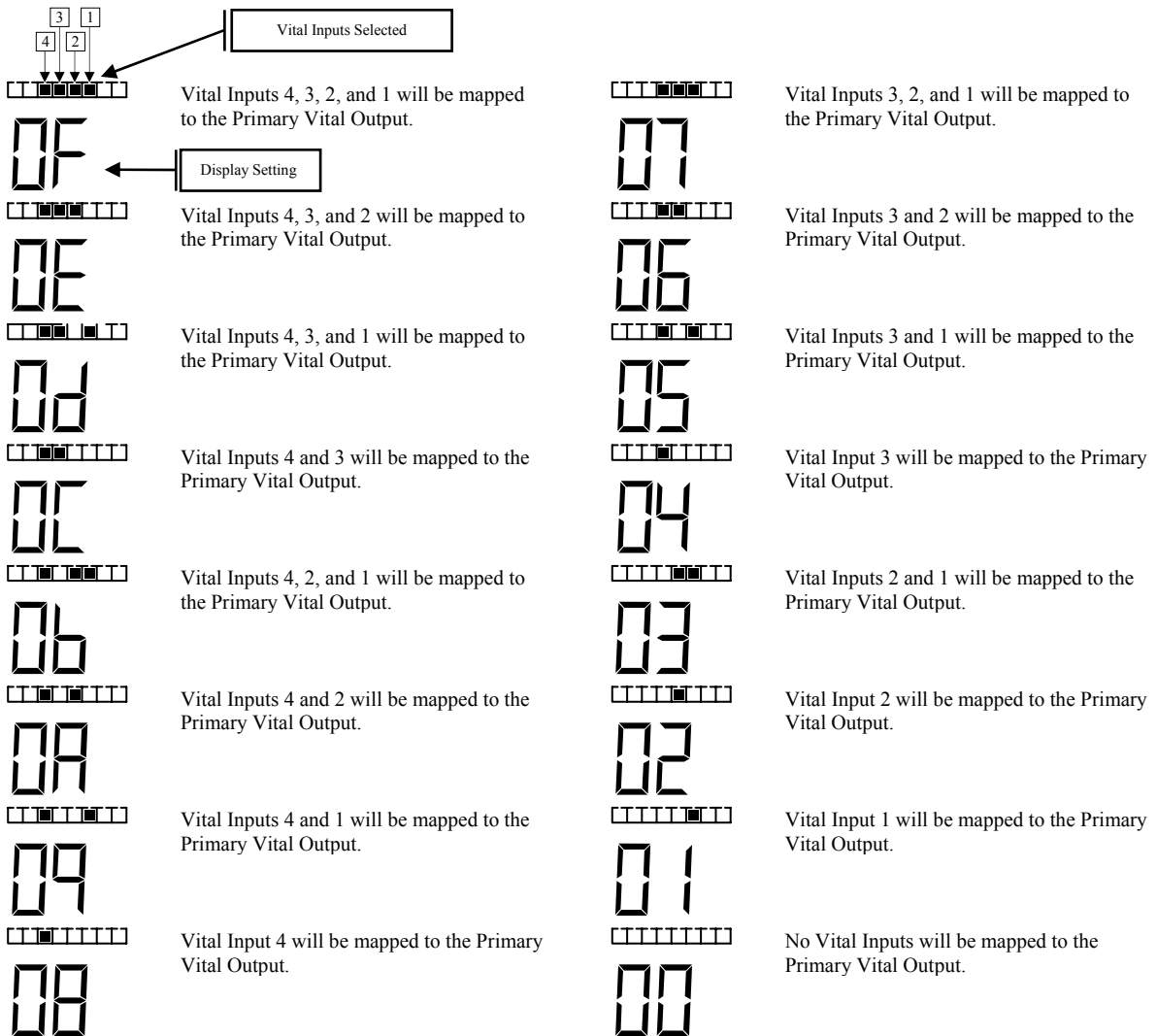

## 5.2.2 Auxiliary Vital Output (*Vital Aux*) Mapping Screens



- PARAMETER** ..... Auxiliary Vital Output (*Vital Aux*) Mapping.
- SETTINGS** ..... 4096 selections - any and all combinations of the four Loop Status Inputs, four Vital Inputs (*Vital In*), and the four Health Status Inputs.
- SETTING DISPLAYED** ..... Bargraph indicates Loop Status Inputs, Vital Inputs, and/or Health Status Inputs mapped to the Auxiliary Vital Outputs. In Loop Status Input mode, the leftmost segment = Loop Status Input 4, next segment = Loop Status Input 3, next segment = Loop Status Input 2, next segment = Loop Status Input 1. In Vital Input mode, the center four segments are used. The leftmost center segment = Vital Input 4, next segment = Vital Input 3, next segment = Vital Input 2, next segment = Vital Input 1. In Health Status Input mode, the rightmost segment = Health Status Input 1, next segment = Loop Status Input 2, next segment = Loop Status Input 3, next segment = Loop Status Input 4. The loop symbol indicates which Auxiliary Vital Output the Loop Status Inputs, Vital Inputs, and/or Health Status Inputs are being mapped to.
- 7-SEGMENT DISPLAY** ..... 7-segment display will show currently selected setting. The first character corresponds to the Loop Status Inputs mapped to the Auxiliary Vital Outputs, the second character corresponds to the Vital Inputs mapped to Auxiliary Vital Outputs, and the third character corresponds to the Health Status Inputs mapped to the Auxiliary Vital Outputs.
- DEFAULT SETTINGS** ..... Auxiliary Vital Output 1 = 000. No Loop Status Inputs mapped to Auxiliary Vital Output 1. No Vital Inputs mapped to Auxiliary Vital Output 1. Health Status Input 1 not mapped to Auxiliary Vital Output 1.  
 Auxiliary Vital Output 2 = 000. No Loop Status Inputs mapped to Auxiliary Vital Output 2. No Vital Inputs mapped to Auxiliary Vital Output 2. Health Status Input 2 not mapped to Auxiliary Vital Output 2.  
 Auxiliary Vital Output 3 = 000. No Loop Status Inputs mapped to Auxiliary Vital Output 3, No Vital Inputs mapped to Auxiliary Vital Output 3. Health Status Input 3 not mapped to Auxiliary Vital Output 3.  
 Auxiliary Vital Output 4 = 000. No Loop Status Inputs mapped to Auxiliary Vital Output 4. No Vital Inputs mapped to Auxiliary Vital Output 4. Health Status Input 4 not mapped to Auxiliary Vital Output 4.
- EXAMPLE** ..... Loop Status Inputs 1, 2, & 3 mapped to Auxiliary Vital Output 1. No Vital Inputs mapped to Auxiliary Vital Output 1. Health Status Inputs 1, 2, 3, & 4 mapped to Auxiliary Vital Output 1.
- NOTES** ..... The characters are displayed in Hexadecimal notation (Base 16).  
 When viewing and/or setting the Auxiliary Vital Output mapping settings, use the FUNC button to advance to the mapping settings of the next Auxiliary Vital Output.  
 An Auxiliary Vital Output is deactivated if no Loop Status Inputs, Vital Inputs, or Health Status Inputs are mapped to it.

To set the mapping status of the Loop Status Inputs, repeatedly press the FUNC button to enter Program Mode and toggle through the set-up parameters until the display screen shows the bargraph and three of the seven-segment display characters. The left character and a loop symbol will flash indicating the current setting and the four leftmost bargraph segments will show the corresponding Loop Status Input mapping. Use the ▲ (UP) or ▼ (DOWN) button to change the setting to the desired configuration. Use the FUNC button to advance to the next Auxiliary Vital Output (indicated by a flashing numbered loop symbol at the bottom of the LCD screen). The various combinations of display characters and bargraph display are shown below.

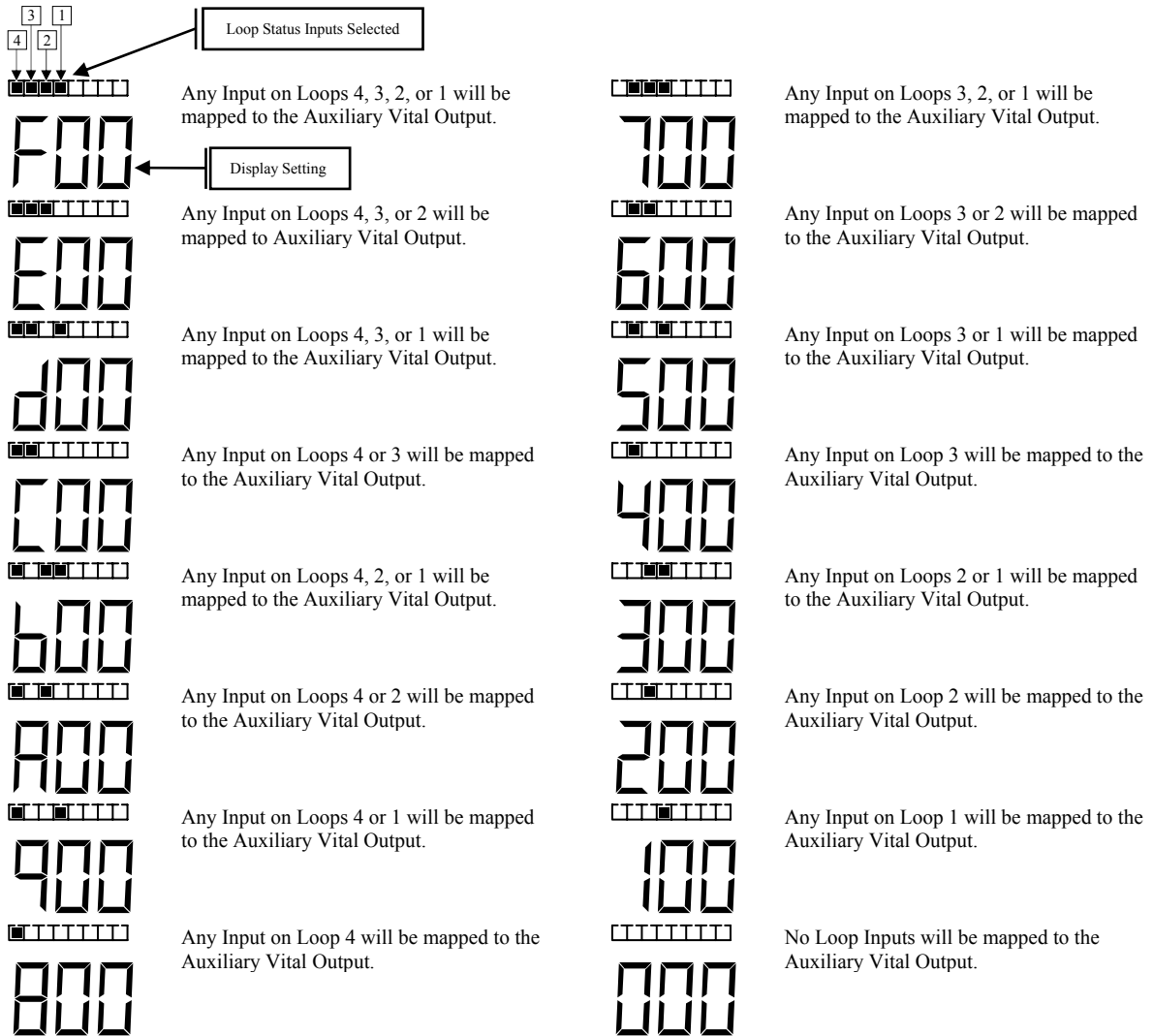

To set the mapping status of the Vital Inputs when in the Auxiliary Vital Output Mapping Program Mode, press the CHAN button once. The center character and a loop symbol will flash indicating the current setting and the center four bargraph segments will show the corresponding Vital Inputs mapping. Use the ▲ (UP) or ▼ (DOWN) button to change the setting to the desired configuration. Use the FUNC button to advance to the next Auxiliary Vital Output (indicated by a flashing numbered loop symbol at the bottom of the LCD screen). The various combinations of display characters and bargraph display are shown below.

When in Normal Mode, repeatedly press the FUNC button to enter Program Mode and toggle through the set-up parameters until the display screen shows the bargraph and three of the seven-segment display characters. The left character and a loop symbol will flash indicating the current setting and the four leftmost bargraph segments will show the corresponding Loop Status Input mapping. Press the CHAN button once. The center character and a loop symbol will flash indicating the current setting and the center four bargraph segments will show the corresponding Vital Inputs mapping. Use the ▲ (UP) or ▼ (DOWN) button to change the setting to the desired configuration. Use the FUNC button to advance to the next Auxiliary Vital Output (indicated by a flashing numbered loop symbol at the bottom of the LCD screen). The various combinations of display characters and bargraph display are shown below.

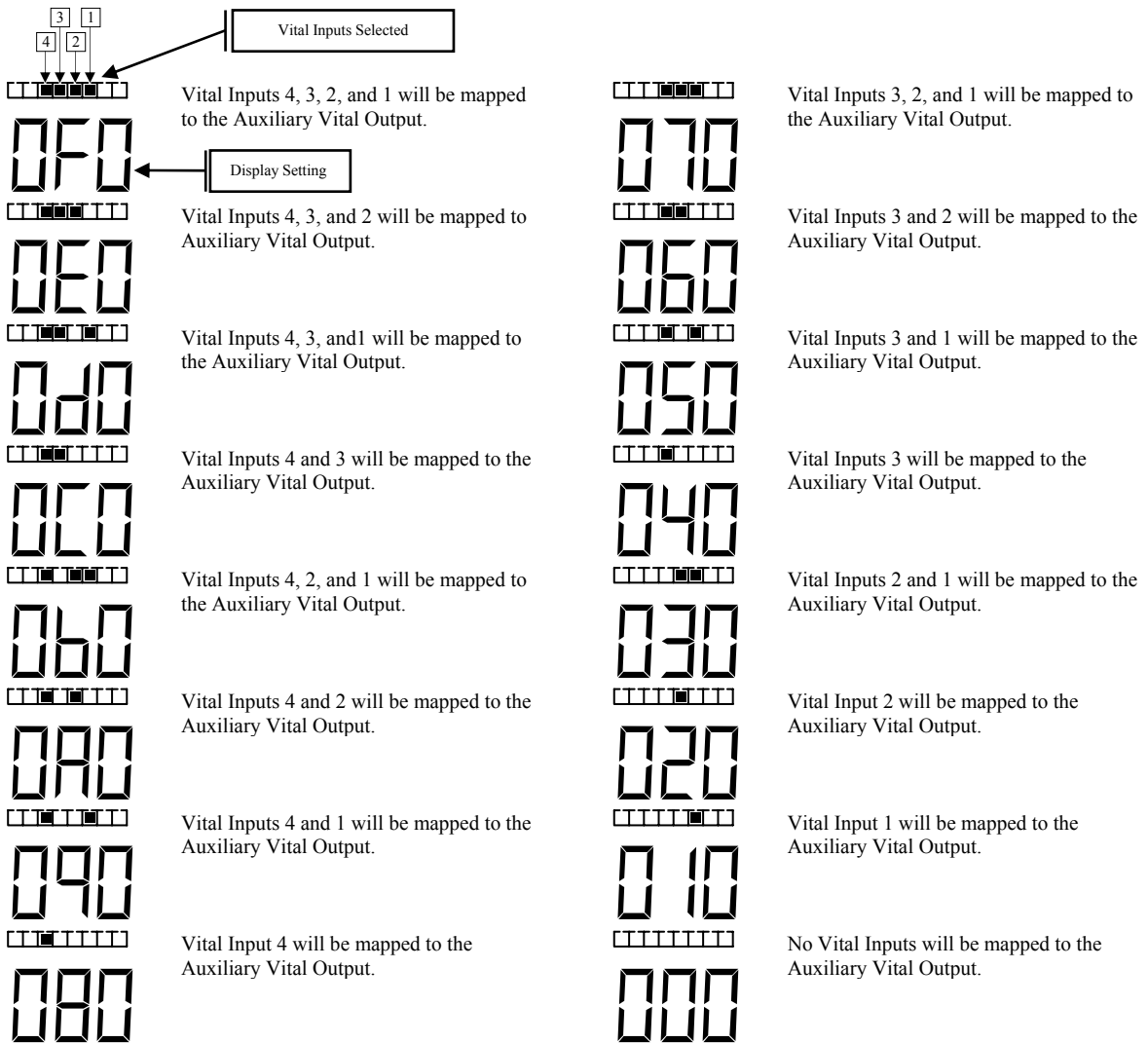

To set the mapping status of the Health Status Inputs when in the Auxiliary Vital Output Mapping Program Mode, press the CHAN button once again. The right character and a loop symbol will flash indicating the current setting and the four rightmost bargraph segments will show the corresponding Health Status Input mapping. Use the ▲ (UP) or ▼ (DOWN) button to change the setting to the desired configuration. Use the FUNC button to advance to the next Auxiliary Vital Output (indicated by a flashing numbered loop symbol at the bottom of the LCD screen). The various combinations of display characters and bargraph display are shown below.

When in Normal Mode, repeatedly press the FUNC button to enter Program Mode and toggle through the set-up parameters until the display screen shows the bargraph and three of the seven-segment display characters. The left character and a loop symbol will flash indicating the current setting and the four leftmost bargraph segments will show the corresponding Vital Input mapping. Press the CHAN button twice. The right character and a loop symbol will flash indicating the current setting and the four rightmost bargraph segments will show the corresponding Health Status Input mapping. Use the ▲ (UP) or ▼ (DOWN) button to change the setting to the desired configuration. Use the FUNC button to advance to the next Auxiliary Vital Output (indicated by a flashing numbered loop symbol at the bottom of the LCD screen). The various combinations of display characters and bargraph display are shown below.

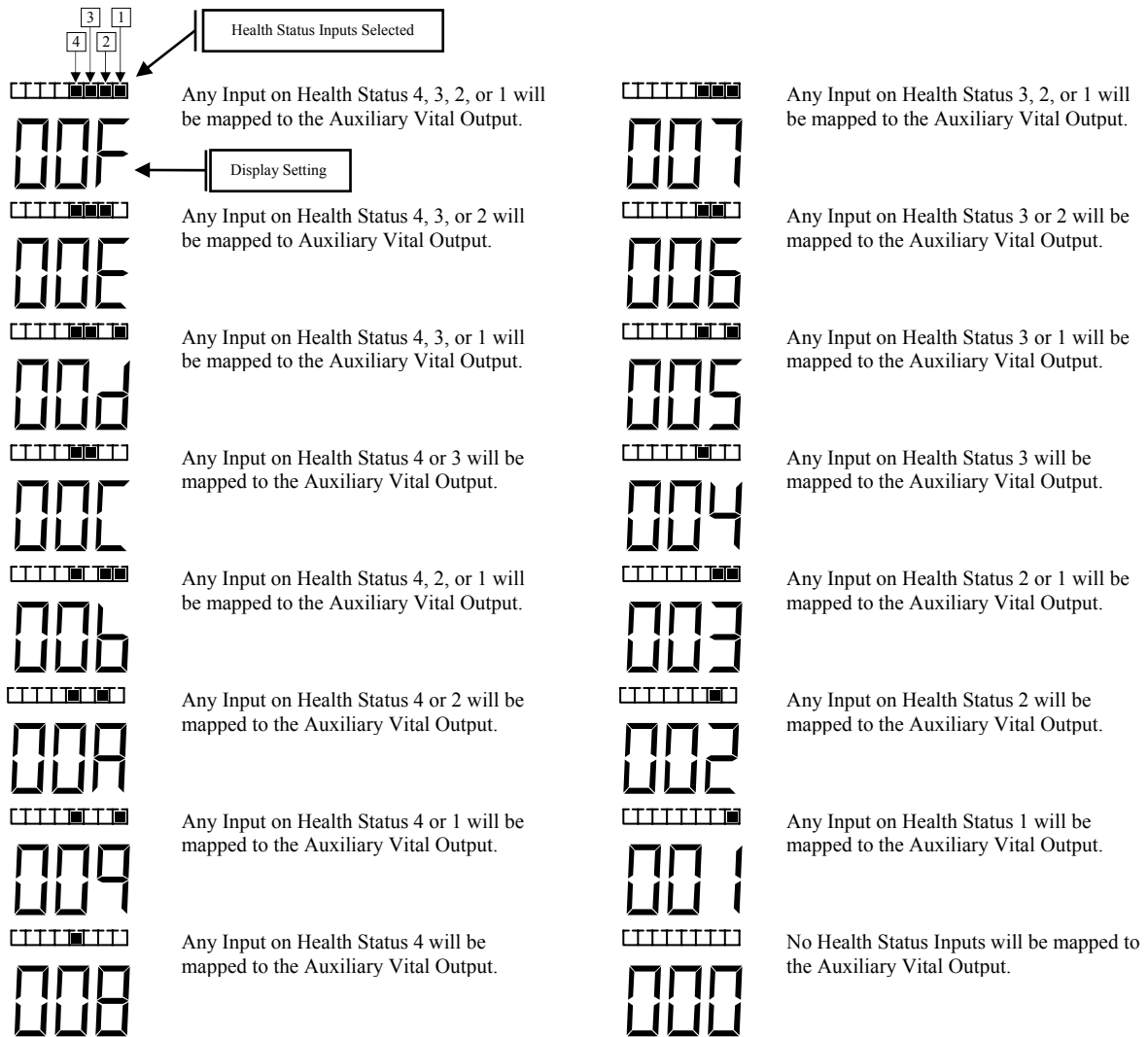

## 5.2 Program Mode Display Screens (cont.)



**PARAMETER** ..... Loop Fail.  
**SETTINGS** ..... Pressing the ▲ (UP) or ▼ (DOWN) button will clear the Loop Fail memory.  
**SETTING DISPLAYED** ..... View only.  
**7-SEGMENT DISPLAY** ..... Loop Failures since the last time it was cleared manually or due to power failure.  
**DEFAULT SETTING** ..... 000.  
**EXAMPLE** ..... There are eight Loop Failures in the accumulator for channel 1.  
**NOTES** ..... Count will be reset to 0 after loss of power, pressing the ▲ (UP) or ▼ (DOWN) button, or a reset input to the Reset terminal on the motherboard.

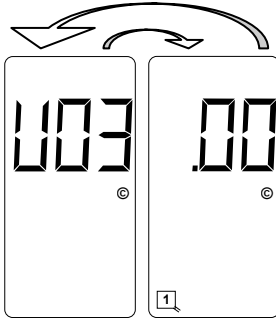

**PARAMETER** ..... Firmware Version and Revision.  
**SETTINGS** ..... View Only.  
**SETTING DISPLAYED** ..... View Only.  
**7-SEGMENT DISPLAY** ..... Model letter and firmware version on one screen and revision on the other. The display will toggle between the two screens with a 50% duty cycle.  
**DEFAULT SETTING** ..... Not Applicable.  
**EXAMPLE** ..... Model U-1400 firmware version 3, revision .00.

## 5.3 Normal Mode Display Screens

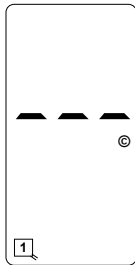

**STATE** ..... Idle.  
**BARGRAPH DISPLAY** ..... Off.  
**7-SEGMENT DISPLAY** ..... Three Dashes.  
**LOOP INPUT LED** ..... OFF.  
**EXAMPLE** ..... Loop Input Channel 1 is idle.  
**NOTES** ..... This is the normal state for a loop input channel when the loop detection zone is unoccupied.



**STATE** ..... Call.  
**BARGRAPH DISPLAY** ..... Number of sensitivity levels inductance change from vehicle exceeds (first dot = current sensitivity level, second dot = next lower sensitivity level, etc.).  
**7-SEGMENT DISPLAY** ..... Call.  
**LOOP INPUT LED** ..... Solid ON.  
**EXAMPLE** ..... Loop Input Channel 1 detection zone is occupied by a vehicle that exceeds the detection threshold by four sensitivity levels.



**STATE** ..... Loop Inductance Display (Option 1 ON).  
**BARGRAPH DISPLAY** ..... OFF if no vehicle is detected. Number of sensitivity levels that the inductance change caused by the vehicle exceeds the detection threshold (first dot = current sensitivity level, second dot = next lower sensitivity level, etc.) if a vehicle is detected.  
**7-SEGMENT DISPLAY** ..... Loop / Lead-In circuit inductance in microHenries. If the value exceeds 999, the display will alternate between the thousands place (1 or 2) and the lower three digits of the inductance value.  
**TEXT** ..... L=  
**LOOP INPUT LED** ..... The loop input LED operates as normal, indicating call as expected.  
**EXAMPLE** ..... Channel 1 Loop / Lead-In circuit inductance is 98 microHenries and it is not detecting a vehicle.  
**NOTES** ..... If Option 2 (-ΔL/L Display) is ON, this display is only shown when the channel is not detecting a vehicle.



**STATE** ..... Loop Inductance - $\Delta L/L$  Display (% Change) (Option 2 ON).  
**BARGRAPH DISPLAY** ..... OFF if no vehicle is detected. Number of sensitivity levels that the inductance change caused by the vehicle exceeds the detection threshold (first dot = current sensitivity level, second dot = next lower sensitivity level, etc.) if a vehicle is detected.  
**7-SEGMENT DISPLAY** ..... Percentage of change in inductance of the Loop / Lead-In circuit.  
**TEXT** ..... - $\Delta L/L$ .  
**LOOP INPUT LED** ..... The loop input LED operates as normal, indicating call as expected.  
**EXAMPLE** ..... Loop Input Channel 1 detection zone is occupied by a vehicle that exceeds the detection threshold by three (3) sensitivity levels and Channel 1 percentage change of inductance is 0.087%.  
**NOTES** ..... This display is only visible while the channel is detecting a vehicle.



**STATE** ..... LCD Display Test.  
**BARGRAPH DISPLAY** ..... All segments on.  
**7-SEGMENT DISPLAY** ..... All segments on.  
**TEXT** ..... All segments on.  
**LOOP INPUT LED** ..... The loop input LED operates as normal, indicating call as expected.  
**EXAMPLE** ..... All segments on.  
**NOTES** ..... This display is visible whenever any two or three pushbutton switches are pressed at the same time.



## 5.4 Error Message Display Screens

The Model U-1400 stores operating parameters and detection reference settings in two places. The detector hardware includes an internally mounted EEPROM and an externally mounted EEPROM memory module. In order for the detector to operate properly, the external EEPROM module shipped with the detector **MUST** be connected to the DB-15 Aux Port connector on the front panel.

Logic programmed into the detector operating firmware continually checks the data stored on the two components listed above. This check function provides a means of verifying several key factors that ensure that the detector is functioning properly. These include:

Detector power up status - Has the detector powered up correctly and is it operating in the correct state?

Detector Failure status - Are failure conditions being identified and is the detector responding to these failures correctly?

Stored data status - Is the data stored on each of the two data storage components consistent with one another?

This phase of the check function allows the user to program the detector with data stored on a master external EEPROM module connected to the DB-15 Aux Port connector on the front panel.

If the information obtained via the check function indicates that there is a problem with some phase of the detector operation, the LCD screen will display one or more of the error messages listed below.

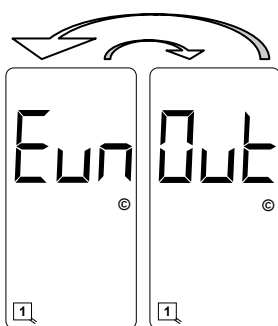

**Uninitialized External EEPROM.** The display will toggle between the two screens shown with a 50% duty cycle. This is an indication that the external EEPROM memory module is missing, that it is not installed properly, or that it is uninitialized. To correct this problem, verify that the module is installed correctly and press the FUNC button. If the error message does not clear, the external EEPROM memory module is defective. Replace it with a functional module and press the FUNC button to clear the error message. If the error message still does not clear, return the detector to the factory for servicing.

**Warning:** If the error message clears after pressing the FUNC button, the user **must** confirm that the stored detector settings are correct for the installation in question.

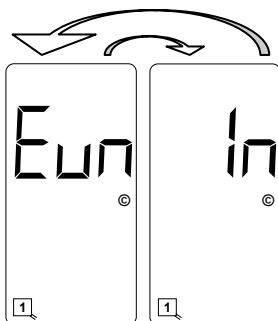

**Uninitialized Internal EEPROM.** The display will toggle between the two screens shown with a 50% duty cycle. This is an indication that the internal EEPROM is uninitialized. To correct this problem, press the FUNC button. If the error message does not clear, the internal EEPROM is defective. Return the detector to the factory for servicing.

**Warning:** If the error message clears after pressing the FUNC button, the user **must** confirm that the stored detector settings are correct for the installation in question.

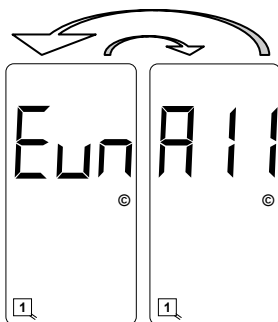

**Uninitialized Internal and External EEPROMs.** The display will toggle between the two screens shown with a 50% duty cycle. This is an indication that the internal EEPROM and the external EEPROM memory module are uninitialized. To correct this problem, press the FUNC button. If the error message does not clear, the internal EEPROM and the external EEPROM memory module are defective. Return the detector to the factory for servicing. NOTE: Clearing this error message will reset the detector to factory default settings and will clear any previously mapped output(s).

**Warning:** If the error message clears after pressing the FUNC button, the user **must** confirm that the stored detector settings are correct for the installation in question.

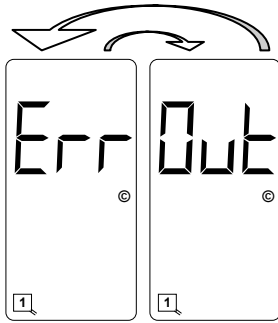

**External EEPROM Error.** The display will toggle between the two screens shown with a 50% duty cycle. This is an indication that the data stored on the external EEPROM memory module is corrupt. Press the FUNC button to copy the reference data stored on the internal EEPROM to the external EEPROM memory module. If the error message does not clear, the external EEPROM memory module is defective. Replace it with a functional module and press the FUNC button to clear the error message. If the error message still does not clear, return the detector to the factory for servicing.

**Warning:** If the error message clears after pressing the FUNC button, the user **must** confirm that the stored detector settings are correct for the installation in question.

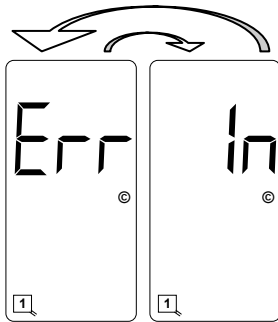

**Internal EEPROM Error.** The display will toggle between the two screens shown with a 50% duty cycle. This is an indication that the data stored on the internal EEPROM is corrupt. Press the FUNC button to copy the reference data stored on the external EEPROM memory module to the internal EEPROM. If the error message does not clear, the internal EEPROM is defective. Return the detector to the factory for servicing.

**Warning:** If the error message clears after pressing the FUNC button, the user **must** confirm that the stored detector settings are correct for the installation in question.

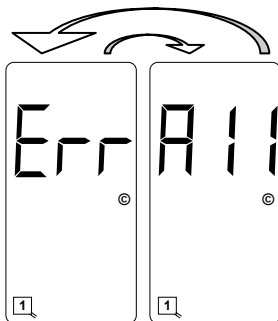

**Internal and External EEPROM Error.** The display will toggle between the two screens shown with a 50% duty cycle. This is an indication that the data stored on the internal EEPROM and the external EEPROM memory module is corrupt. Press the FUNC button to copy the reference data stored on the microprocessor to the internal EEPROM and the external EEPROM memory module. If the error message does not clear, the internal EEPROM and the external EEPROM memory module are defective. Return the detector to the factory for servicing. NOTE: Clearing this error message will reset the detector to factory default settings and will clear any previously mapped output(s).

**Warning:** If the error message clears after pressing the FUNC button, the user **must** confirm that the stored detector settings are correct for the installation in question.



**Detection Reference Error.** This is an indication that the internal EEPROM and the external EEPROM memory module detection reference values do not match. Press the FUNC button to clear the error message.

**Warning:** If the error message clears after pressing the FUNC button, the user **must** confirm that the stored detector settings are correct for the installation in question.

**Warning:** Clearing this error will reset all internal and external detection reference values. If a vehicle (or vehicles) is (are) present over any or all loops at this time, the inductance change caused by the vehicle(s) will be incorporated into the new baseline detection reference and the vehicle(s) will no longer be detected.

## 5.5 Loop Check Pass / Fail Indications



Loop Check  
Pass  
Indication

The Loop Check feature is enabled whenever the Loop Check Timer for a specific loop input is set to a value between 1 and 255 minutes. When the Loop Check Timer has timed out, the detector will automatically short the check loop to simulate vehicle detection. If the percentage of inductance change is greater than or equal to  $-0.04\% \Delta L/L$ , and the channel on which the current loop check test is selected and being viewed on the LCD, the display will show **PAS**.



Loop Check  
Pending  
Indication

If the percentage of inductance change caused by activating the check loop is less than  $-0.04\% \Delta L/L$ , the detector will initiate its check loop verification process. The LCD screen will display an indication of a pending state (**Pcl**) during the check loop verification. This screen will flash for 55 seconds until one of three things happen; the check loop verification fails (indication shown below - **Lcl**), the check loop(s) causing the check loop verification is (are) connected or restored to a functional state (indication shown above - **PAS**), or the check loop(s) causing the check loop verification is (are) turned off, i.e. the Loop Check Timer of the loop(s) is set to 000.

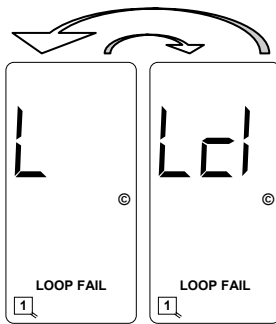

Loop Check  
Failure  
Indication

If the check loop verification fails, the LED corresponding to that loop channel will begin flashing at a three Hz rate. If the channel corresponding to the check loop failure is selected and being viewed on the LCD, the display will toggle between a screen showing **L** and **LOOP FAIL** and a screen showing **Lcl** and **LOOP FAIL** with a 50% duty cycle to indicate that a Loop Check failure has occurred. In addition, the loop status will enter the Call state and the Health Status will enter the **Fail** condition. A Loop Check failure will deactivate any Primary Vital Output to which any loop input or Health Status is mapped. When the Health Status of one or more loop inputs is (are) mapped to an Auxiliary Vital Output, a loop check failure will deactivate the Auxiliary Vital output.

Disabling the Loop Check feature (setting the Loop Check Timer to zero), powering down the detector, or resetting the channel that failed the loop check test will clear the Loop Check failure. However, if the problem that caused the Loop Check failure is not corrected, the channel will fail the next loop check test.

The Loop Check feature is suppressed if the loop has an open, a shorted, or a relative ( $\pm 25\% \Delta L/L$ ) failure.

The detector will perform a loop check test on all programmed channels two seconds after start-up or two seconds after a reset.

NOTE: If the Loop Check Timer is set to 000, the Loop Check function is off.

## 5.6 Vital Input (*Vital In*) Status / Fail Indications

Each of the four Vital Inputs has a dedicated, dual color (green / red) LED which illuminates in various ways to indicate the state of the Vital Input. When the LED is off, the Vital Input is deactivated (low voltage level). When the LED displays as solid green, the Vital Input is activated (high voltage level). When the LED displays as solid red, the Vital Input has failed its self-check.

## 5.7 Primary Vital Output (*Vital Out*) Status / Fail Indications

Each of the four Primary Vital Outputs has a dedicated, dual color (green / red) LED which illuminates in various ways to indicate the state of the Primary Vital Output. When the LED is off, the Primary Vital Output is deactivated (low voltage level). When the LED displays as solid green, the Primary Vital Output is activated (high voltage level). When the LED displays as a two Hz flashing green, timing delay is activated and the Primary Vital Output is functioning (low voltage level until delay times out). When the LED displays as a five Hz flashing green, timing extension is activated and the Primary Vital Output is functioning (low voltage level until extension times out). When the LED displays as solid red, the Primary Vital Output has failed its self-check.

## 5.8 Auxiliary Vital Output (*Vital Aux*) Status / Fail Indications

Each of the four Auxiliary Vital Outputs has a dedicated, dual color (green / red) LED that illuminates in various ways to indicate the state of the Auxiliary Vital Output. When the LED is off, the Auxiliary Vital Output is deactivated (low voltage level). When the LED displays as solid green, the Auxiliary Vital Output is activated (high voltage level). When the LED displays as solid red, the Auxiliary Vital Output has failed its self-check.

## 5.9 Synch Fail Indications

### 5.9.1 Series Synch Fail Indications



Series  
Synch Mode  
Failure  
Indication

When the Synch feature is set to operate in Series Synch mode (Option 7 is set to 7.01), the LCD will display *SYS*. If, after completing the sampling routine, the detector determines there is a failure on one or more loop inputs, the LCD will display *FSY* and continue sampling. If the Synch failure is cleared, the fail indication (*FSY*) will no longer be displayed on the LCD.

### 5.9.2 Parallel Synch Fail Indications



Parallel  
Synch Mode  
Failure  
Indication

When the Synch feature is set to operate in Parallel Synch mode (Option 7 is set to 7.02), the LCD will display *SYP*. If, after completing the sampling routine, the detector determines there is a failure on one or more loop inputs, the LCD will display *FSY* and continue sampling. If the Synch failure is cleared, the fail indication (*FSY*) will no longer be displayed on the LCD.

## 5.10 Loop Fail Indications

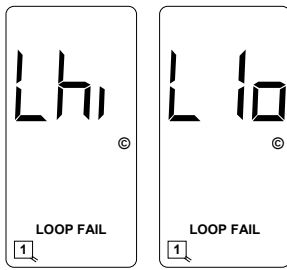

+25%  
change or  
open loop  
condition.

-25%  
change or  
shorted loop  
condition.

If the total inductance of a channel's loop input network goes out of the range specified for the detector, or rapidly changes by more than  $\pm 25\%$ , the loop input channel will enter the Fail-Safe mode and display **LOOP FAIL** on the LCD. The type of loop failure will also be displayed as **L lo** (for -25% change or shorted loop conditions) or **L hi** (for +25% change or open loop conditions). This will continue as long as the loop fault exists. Fail-Safe mode generates a continuous call. At the time of a loop failure, the loop input channel's LED will begin to flash at a rate of three flashes per second. The LED will continue this display pattern until the channel is manually reset or power is removed.

If the loop self-heals, the **LOOP FAIL** message on the LCD will extinguish and the loop input channel will resume operation in a normal manner; except, the LED will continue the three flashes per second display pattern, thus, providing an alert that a prior Loop Fail condition has occurred. Each loop failure is counted and accumulated into the Loop Fail Memory. The total number of loop failures for the loop input channel (since the last power interruption or manual reset) is written into the Loop Fail Memory and can be seen by stepping through the channel's functions in Program Mode to the LOOP FAIL display.

This is a useful tool that can be used to identify intermittent loop problems. If the count is extremely high for the period of time observed, the problem is very likely a loose connection (check for loose connections at the terminal strip and bad splices in the field). The Loop Fail Count is reset when power is removed from the detector. This prevents the Loop Failure Count from moving to another loop if the detector is moved to a new location.

To view the Loop Fail Count, select the desired loop input channel using the CHAN button then repeatedly press the FUNC button until the **LOOP FAIL** display is shown. The Loop Fail Count display is after the OPTION displays. Pressing the ▲ (UP) or ▼ (DOWN) button while the Loop Fail Count is displayed, will reset the count to zero.

## 5.11 Setting Sensitivity using the Bargraph

The bargraph is a graphical representation of the relative change of inductance as seen by the detector loop input channel; automatically taking into account sensitivity setting, loop geometry, configuration, lead-in length, etc. The first bargraph segment represents the minimum inductance change (set by the sensitivity level) necessary for the loop input channel to output a call. Each additional segment represents the inductance change in excess of the next sensitivity threshold. Usually, the larger the vehicle detected, the more bargraph segments displayed, i.e. the greater the  $-\Delta L/L$ . The bargraph can be used to select the proper sensitivity level.

The bargraph below shows the deflection (3 segments) of a vehicle with Sensitivity set to Level 5. The vehicle in the loop zone is causing a change of inductance greater than 1.28%  $-\Delta L/L$  or Sensitivity Level 3.

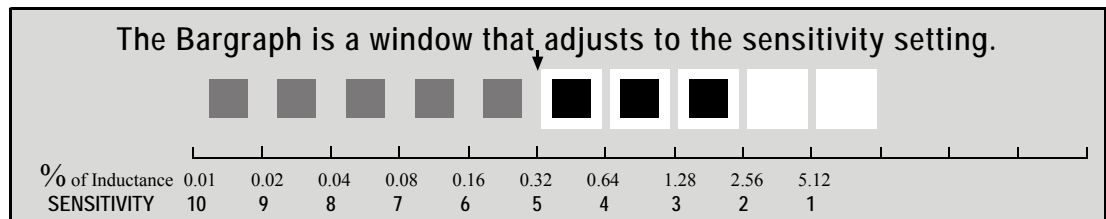

The bargraph below has the same vehicle in the loop zone causing the same inductance change as above. Because the sensitivity setting was increased to Level 8, six segments are now displayed. If the bargraph displays 5 or 6 segments for a vehicle in the loop, the sensitivity has been set to the proper range.

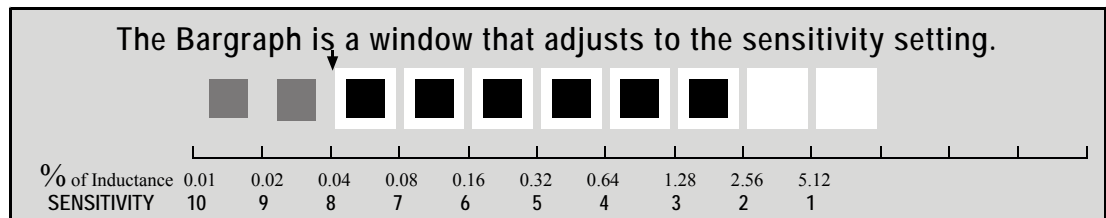

### 5.12 Full Restore To Factory Default Settings

Pressing all four front panel switches simultaneously and continuously for five (5) seconds resets the detector and restores all the factory default settings. The countdown of the five second period is displayed on the LCD. Releasing any of the switches before the countdown ends aborts the Full Restore operation. (See Default Settings).  
NOTE: Resetting the detector to factory default settings will clear any previously mapped output(s).

### 5.13 Diagnostic Features Activation

When the detector is operating in normal mode, pressing either the ▲ (UP) or ▼ (DOWN) button will temporarily activate Option 1 (Loop Inductance Display) and Option 2 (Loop Inductance - $\Delta$ L/L Display) for all loop inputs and Option 6 (Audible Detect Signal) for the loop input indicated in the lower portion of the LCD. All three of these diagnostic options will remain active for 15 minutes.

### 5.14 Display Test

Pressing any two or three of the front panel switches simultaneously will turn on all possible symbols and messages on the LCD screen.

### 5.15 Changing or Relocating Detectors

The Model U-1400 detector stores user-programmed parameters on an internally mounted EEPROM and an external EEPROM located in a removable memory module that is included with the detector. This allows the user to change or relocate detectors and reset the parameters that were programmed for a particular site or detector. When a new detector is installed or an existing detector is relocated, an Error message will appear on the LCD. The LCD will alternate between *Cpy* and *In*. This message means that the parameters stored on the internal EEPROM do not match the parameters stored on the external EEPROM module. At this point, the user has two choices. Pressing the FUNC button will accept the parameters stored on the internal EEPROM and store them on the external EEPROM module. Pressing either the ▲ (UP) or ▼ (DOWN) button will change the alternating message on the LCD to *Cpy* and *Out*. Pressing the FUNC button will accept the parameters stored on the external EEPROM module and store them on the internal EEPROM.

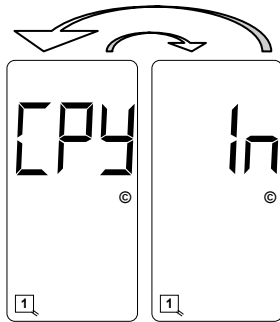

Parameters stored on the external EEPROM memory module do not match those stored on the internal EEPROM. Pressing the FUNC button will accept the parameters stored on the internal EEPROM and store them on the external EEPROM memory module, i.e. copy the internal EEPROM parameters to the external EEPROM memory module.

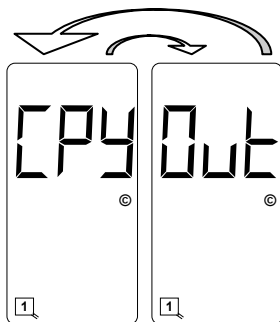

Parameters stored on the external EEPROM memory module do not match those stored on the internal EEPROM. Pressing the FUNC button will accept the parameters stored on the external EEPROM memory module and store them on the internal EEPROM, i.e. copy the external EEPROM memory module parameters to the internal EEPROM.

## 6.0 BLOCK DIAGRAM

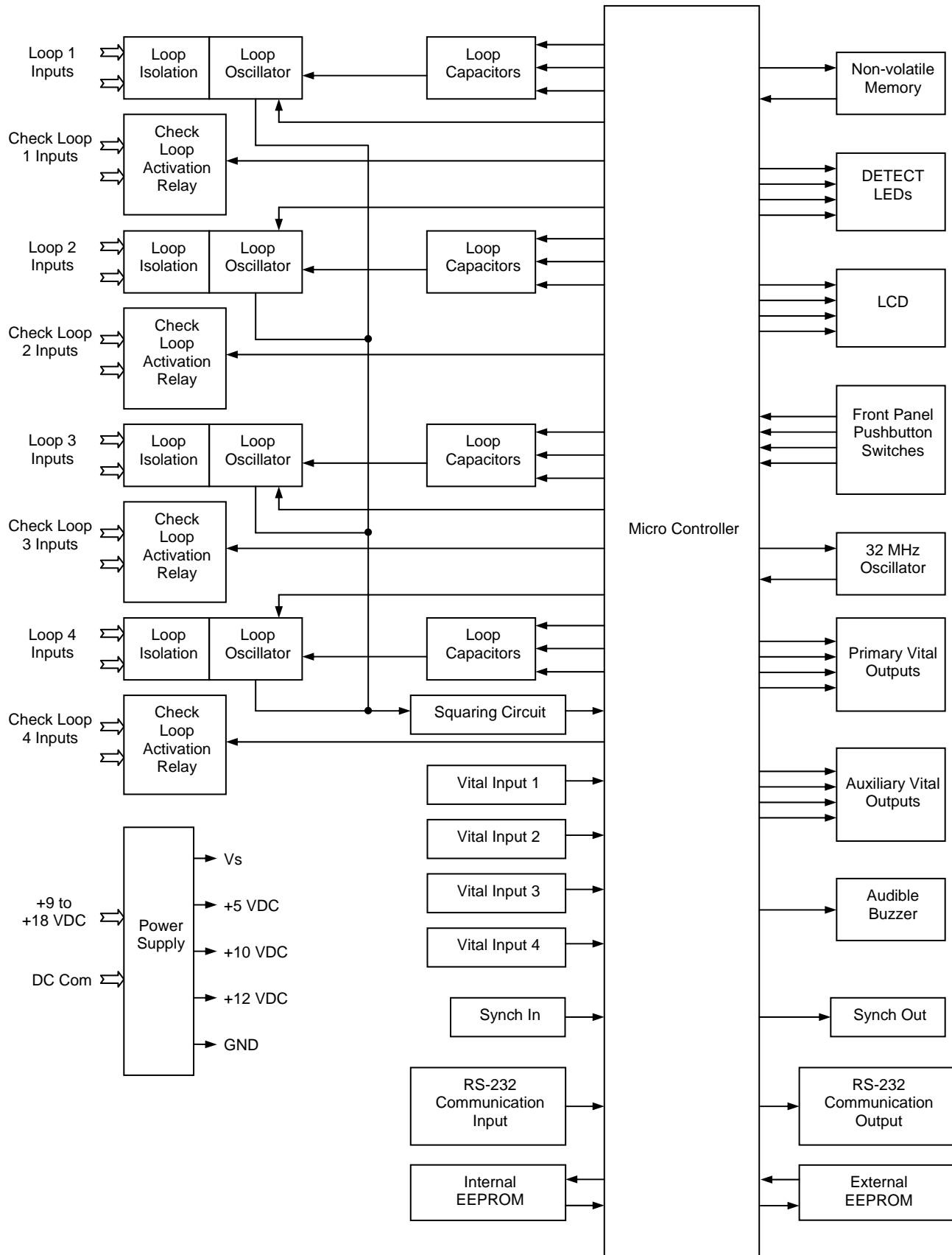

## 7.0 THEORY OF OPERATION

The Reno A & E Model U-1400 detector digitally measures changes in the resonant frequency of four independent loop circuits to determine if a vehicle has entered the detection zone. The Model U-1400 detector applies an excitation voltage to each loop circuit resulting in the loops oscillating at their resonant frequencies. The current flow in the loop wire creates magnetic fields around the loop wire. When a vehicle passes over the loop area, the conductive metal of the vehicle causes a loading of the loop's magnetic fields. The loading decreases the loop inductance, which causes the resonant frequency to increase. By continuously sampling the loop's resonant frequency, the magnitude and rate of change can be determined. If the frequency change exceeds a selectable threshold (set by the sensitivity settings), the detector will deactivate a vital output if one is mapped. If the rate of change is slow, typical of environmental drift, the detector will continuously track and compensate for the change. The Model U-1400 detector also monitors the loop frequency for out of range conditions such as an open or shorted loop circuit.

The Model U-1400 detector is a scanning detector. The scanning method sequentially turns on and off each channel's loop oscillator. Each channel's oscillator circuit supplies the excitation voltage that is coupled to the loop circuit by a loop isolation transformer. The transformer provides high common mode isolation between the loop and detector electronics, which allows the detector to operate on poor quality loops including a single short to ground. The transformer also limits the amount of static energy (lightning) that can transfer to the detector electronics. A spark gap transient suppression device is connected across the loop inputs connected to the isolation transformer. This device dissipates static charges prior to the transformer. A network of four capacitors is connected to the detector side of the isolation transformer. Three of the capacitors can be switched in or out of the oscillator circuit to shift the frequency of the loop oscillator circuit thus providing frequency separation between adjacent loops. The three switchable capacitors are electronically switched using FETs and are selected when programming parameter values with the front panel pushbutton switches.

The outputs from the four loop oscillators are tied together and fed into a common squaring circuit. This is possible since the detector is a scanning detector allowing only a single loop oscillator to be operating at any given time. The sine wave from each loop oscillator circuit is squared to provide a precise zero crossing signal for the input to the microcontroller. This signal is called the loop sample. The loop sample is an integral number of complete oscillations from the loop oscillator circuit. The number of loop oscillations counted is a function of the selected sensitivity setting for the detector channel. The required number of loop oscillations needed for a loop sample increases as the sensitivity setting is increased. The microcontroller uses the period of the loop sample for accumulating high-speed (32 MHz) crystal clock pulses generated by the microcontroller's internal high-speed crystal oscillator. The number of crystal clock pulses accumulated during consecutive loop samples is compared to the internal reference number of crystal clock pulses stored in the microcontroller's memory.

When a vehicle enters the loop zone the loop inductance decreases. This decrease in loop inductance causes an increase in the loop oscillator frequency. In turn, an increase in loop oscillator frequency results in a decrease of the time period for the loop sample. Hence, when a vehicle enters the loop zone, the number of crystal clock pulses accumulated during a loop sample period decreases. By comparing the new count with the reference count, a percentage change can be calculated that indirectly relates to the inductance change. If the magnitude of the change exceeds a selectable threshold (sensitivity setting), the detector deactivates a vital output if one is mapped. The rate of change is also monitored. Slow rates of change caused by environmental fluctuations are tracked and automatically compensated for. This process is conducted independently for each of the four loop oscillator circuits.

The microcontroller uses the high-speed crystal clock count to calculate the loop inductance, frequency and percentage of change. If selected, the values are displayed on the seven-segment LCD. The microcontroller also processes the pushbutton switch selections for the LCD display and stores the operating parameters in non-volatile memory. Stored parameters are changed with the front panel switches or via the front panel RS-232 communications port and are unaffected by loss of power or detector reset. The microcontroller continuously processes the loop samples and detector operation is not effected during the operation of the switches or the LCD. NOTE: When either the sensitivity or frequency of a loop input channel is changed, the loop input channel is reset.

In addition, the microcontroller conditions the outputs based on Loop Status Inputs, Vital Inputs, Health Status Inputs, and the programmed settings of the various timers (Primary Vital Output Delay, Primary Vital Output Extension, and Loop Check) and options (Option 1, Option 2, Option 3, Option 4, Option 5, Option 6 and Option 7).



## 8.0 MAINTENANCE AND TROUBLESHOOTING

The Reno A & E Model U-1400 Detector requires no maintenance. If you are having problems with a Model U-1400 detector, use the troubleshooting tips below to help determine the cause of the problem.

### 8.1 Basic Troubleshooting Tips

#### Detector Enclosure Checks:

Verify correct input voltage to the detector.

Check the detector diagnostics. If there is a current loop failure or the loop fail memory shows a loop failure has occurred, the problem is probably not related to the detector module.

Check the loop / lead-in cable resistance of the detect loops and the check loops. A value greater than five Ohms is an indication of a splice or connection problem or a broken loop wire.

Disconnect the detect loop or check loop from the detector. Use a 500 VDC Megger to measure the resistance from one of the loop wires to earth ground. It should be greater than 50 megOhms. If lower, separate the splice at the pull box and isolate the problem to the loop or lead-in cable.

Verify all terminal screws are tight.

Inspect all loop connections in the detector enclosure, especially crimped lug connections. If suspect, solder the lugs to the wire.

If the lightning or surge suppression devices on the loop inputs in the detector enclosure are suspect, remove or replace them.

Check for places in the detector enclosure where the harness wires or lead-in cable may be pinched or chaffed.

Make sure that each pair of interconnect (lead-in) wires for the loop(s) are individually twisted together.

#### Field Checks:

Inspect the loop. Look for exposed wires, debris pressed into the loop wires, pavement shifts, etc.

Check splices in the pull box. They must be soldered and waterproofed. DO NOT USE WIRE NUTS.

Check that each set of loop lead-in wires in each pull box is twisted together [six (6) twists per foot, minimum] and that lead-in lengths are not excessive.

## 8.2 Things To Know About Loops

Always use a wire with cross-linked Polyethylene insulation (insulation type XLPE) for loop wire.

Typical sensing height is  $\frac{2}{3}$  of the shortest leg of a loop. Therefore, a 6' x 6' loop will have a detection height of 4'.

The inductance of a conventional four-sided loop can be estimated using the formula:

$$L = P \times (T^2 + T) / 4$$

Where: L = Loop Inductance in microhenries  
P = Loop Perimeter in feet  
T = Number of Turns of Wire.

Therefore, a 6' by 6' loop with 3 turns would have an inductance of:

$$\begin{aligned} L &= (6 + 6 + 6 + 6) \times (3^2 + 3) / 4 \\ L &= 24 \times (9 + 3) / 4 \\ L &= 24 \times 12 / 4 \\ L &= 24 \times 3 \\ L &= 72 \text{ microhenries.} \end{aligned}$$

The inductance of a Quadrupole™ loop can be estimated using the formula:

$$L = [P \times (T^2 + T) / 4] + [CL \times (T^2 + T) / 4]$$

Where: L = Loop Inductance in microhenries  
P = Loop Perimeter in feet  
T = Number of Turns of Wire  
CL = Length of Center Leg in feet.

Therefore, a 6' by 50' loop with a 2-4-2 configuration would have an inductance of:

$$\begin{aligned} L &= [(6 + 50 + 6 + 50) \times (2^2 + 2) / 4] + [50 \times (4^2 + 4) / 4] \\ L &= [112 \times (4 + 2) / 4] + [50 \times (16 + 4) / 4] \\ L &= (112 \times 6 / 4) + (50 \times 20 / 4) \\ L &= (112 \times 1.5) + (50 \times 5) \\ L &= 168 + 250 \\ L &= 418 \text{ microhenries.} \end{aligned}$$

Loop Feeder cable typically adds 0.22 microhenries of inductance per foot of cable.

Total inductance of loops connected in series:  $L_{TOTAL} = L_1 + L_2 + L_3 + \dots + L_N.$

Total inductance of loops connected in parallel:  $L_{TOTAL} = 1 / [ (1 / L_1) + (1 / L_2) + (1 / L_3) + \dots + (1 / L_N) ].$

This page intentionally left blank.